

User Guide

PANTUM

WWW.PANTUM.COM

Pantum CM1100 Series Color laser multifunction printer (FB model)



It is recommended that you read this Guide carefully before using the printer

Preface

Welcome to the Pantum Series products!

We heartily appreciate your using of Pantum Series products!

To protect your vital interests, please carefully read the following statements.

Legal Notice

Trademark

Pantum and Pantum logos are registered trademarks of Zhuhai Pantum Electronics Co.,Ltd. Microsoft®, Windows®, Windows Server® and Windows Vista® are trademarks registered by Microsoft Corporation in the United States or other countries/regions.

Mopria®, the Mopria® Logo, and the Mopria Alliance™ word mark and logo are registered and/or unregistered trademarks and service marks of Mopria Alliance, Inc. in the United States and other countries. Unauthorized use is strictly prohibited.

Apple, AirPrint and Mac are trademarks of Apple Inc., registered in the U.S. and other countries. Use of the Works with Apple badge means that an accessory has been designed to work specifically with the technology identified in the badge and has been certified by the developer to meet Apple performance standards.

Wi-Fi Direct, Wi-Fi Protected Setup(WPS), WPA, WPA2, and Wi-Fi Protected Access are marks of the Wi-Fi Alliance.

The ownership to the names of the software in this User Guide belongs to their respective companies in accordance with corresponding license agreement, and they are referred for instructions only.

All other product and brand names herein may be the registered trademarks, trademarks or service marks of their respective owners, and they are referred for instructions only.

Copyright

The Copyright of this User Guide is owned by Zhuhai Pantum Electronics Co.,Ltd.

It is prohibited to copy, translate, modify and transmit this User Guide by any means or in any form without the prior written consent of Zhuhai Pantum Electronics Co.,Ltd.

Version:V1.0

Disclaimer

For a better user experience, Zhuhai Pantum Electronics Co.,Ltd. reserves the right to make changes to the User Guide. The information contained herein is subject to change without notice. Users are responsible for any damages arising from failing to follow this User Guide. Meanwhile, except the express warranty made in the product maintenance manual or service commitment, Zhuhai Pantum Electronics Co.,Ltd. does not make any express or implied warranty or guarantee to this User Guide (including composing or words).

Using this product to copy, print, scan certain documents or images or make other forms of operations may be prohibited by the local laws. If you are uncertain about the legality of using this product for certain documents or images, you should consult your legal advisor in advance.

The product can only be used safely in the non-tropical areas at an altitude no higher than 2000 meters.

Safety Precautions

Disconnect the power supply

The product should be placed close to or easily accessible to power sockets, so as to allow easy disconnection of power supply!









Laser Safety

The laser radiation is harmful to the human body. Since laser components are completely sealed in the printer, laser radiation will not leak. To avoid laser radiation, please do not randomly disassemble the printer!

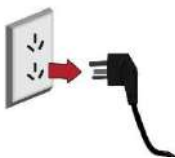
The printer follows the provisions of Class 1 laser products under CFR standard. The printer has a Class III b laser diode, which has no laser radiation leakage among laser components. The laser components shall comply with the requirements of: U.S. Code of Federal Regulations, 21 CFR 1040, IEC 60825-1.

Safety Warning

Please note the following safety warnings before using the printer:

|  Warning | |
|---|---|
|  There is high-voltage electrode inside the printer. Before cleaning the printer, make sure the power is turned off! |  |
|  Plugging and unplugging the power cord plug with a wet hand can result in an electric shock. |  |
|  The fuser unit is hot when and after printing. Touching the fuser unit (the shaded area as shown) may cause burns! |  |
|  The fuser unit is attached with a high temperature warning label. Please do not remove or damage this label. |  |

Safety Information

Conventions

CAUTION: A caution indicates a potentially hazardous situation that could injure you.

Note: A note indicates the information that could help you or something that could damage the product hardware or software.

Different types of caution statements include::



CAUTION - POTENTIAL INJURY: Indicates a risk of injury.



CAUTION - SHOCK HAZARD: Indicates a risk of electrical shock.



CAUTION - HOT SURFACE: Indicates a risk of burn if touched.



CAUTION - TIPPING HAZARD: Indicates a crush hazard.



CAUTION - PINCH HAZARD: Indicates a risk of being caught between moving parts.



CAUTION - ROTATING FAN BLADES: Indicates a risk of being lacerated by moving fan blades.

Disclaimer



CAUTION - POTENTIAL INJURY: To avoid the risk of fire or electrical shock, connect the power cord to an appropriately rated and properly grounded electrical outlet that is near the product and easily accessible.



CAUTION - POTENTIAL INJURY: To avoid the risk of fire or electrical shock, use only the power cord provided with this product or the manufacturer's authorized replacement.



CAUTION - POTENTIAL INJURY: Do not use this product with extension cords, multioutlet power strips, multioutlet extenders, or UPS devices. The power capacity of these types of accessories can be easily overloaded by a laser printer and may result in a risk of fire, property damage, or poor printer performance.



CAUTION - POTENTIAL INJURY: Do not use this product with an inline surge protector. The use of a surge protection device may result in a risk of fire, property damage, or poor printer performance.



CAUTION - SHOCK HAZARD: To avoid the risk of electrical shock, do not place or use this product near water or wet locations.



CAUTION - SHOCK HAZARD: To avoid the risk of electrical shock, do not set up this product or make any electrical or cabling connections during a lightning storm.



CAUTION - POTENTIAL INJURY: Do not cut, twist, bind, crush, or place heavy objects on the power cord. Do not subject the power cord to abrasion or stress. Do not pinch the power cord between objects such as furniture and walls. If any of these things happen, it could result in a risk of

fire or electrical shock. Inspect the power cord regularly for signs of such problems. Remove the power cord from the electrical outlet before inspecting it.



CAUTION - SHOCK HAZARD: To avoid the risk of electrical shock, make sure that all external connections (such as Ethernet) are properly installed in their marked plug-in ports.



CAUTION - SHOCK HAZARD: To avoid the risk of electrical shock, if you are accessing the controller board or installing optional hardware or memory devices after setting up the printer, turn the printer off, and unplug the power cord from the electrical outlet before continuing. If you have any other devices attached to the printer, turn them off as well, and unplug any cables going into the printer.



CAUTION - SHOCK HAZARD: To avoid the risk of electrical shock when cleaning the exterior of the printer, unplug the power cord from the electrical outlet and disconnect all cables from the printer before proceeding.



CAUTION - POTENTIAL INJURY: If the printer weighs more than 18 kg, then it requires two or more trained personnel to lift it safely.



CAUTION - POTENTIAL INJURY: When moving the printer, follow these guidelines to avoid personal injury or printer damage:

- Make sure that all covers and trays are closed.
- Turn off the printer, and then unplug the power cord from the electrical outlet.
- Disconnect all cords and cables from the printer.
- If the printer has casters on its base, then carefully move it to the new location. Use caution when passing over thresholds and breaks in flooring.
- Always use the handholds on the printer to lift it.
- Any cart used to move the printer must have a surface able to support the full footprint of the printer.
- Keep the printer upright.
- Avoid violent vibrations when moving.
- Make sure that your fingers are not under the printer when you set it down.
- Make sure that there is adequate clearance around the printer.



CAUTION - HOT SURFACE: The inside of the printer might be hot. To reduce the risk of injury by a hot component, allow the surface to cool before touching it.



CAUTION - HOT SURFACE: Some parts of the printer are still in high temperature within a short time after use. To prevent burns, please don't directly touch places labeled with high temperature warning in contact with internal components after opening the printer's front or rear cover.



CAUTION - PINCH HAZARD: To avoid the risk of a pinch injury, use caution in areas marked with this label. Pinch injuries may occur around moving parts, such as gears, covers, trays, and covers.



CAUTION - ROTATING FAN BLADES: To avoid the risk of laceration from moving fan blades, turn off the printer and unplug the power cord from the electrical outlet before accessing areas marked with this symbol.



CAUTION - POTENTIAL INJURY: This product uses lasers. Use of controls or adjustments or performance of procedures other than those specified in the User's Guide may result in hazardous radiation exposure.

This product is designed, tested, and approved to meet strict global safety standards with the use of specific manufacturer's components. The safety features of some parts may not always be obvious. The manufacturer is not responsible for any adverse consequences caused by using parts of other manufacturers.

For services or repairs other than those described in the user document, please contact the Customer Service Center.

This product uses a printing process that heats the print media, and the heat may cause the media to release emissions. Please read and understand the section in your operating instructions that discusses the guidelines for selecting print media properly to avoid the possibility of harmful emissions.

This product may produce a small amount of ozone during normal operation, and may be equipped with a filter designed to limit ozone concentrations to levels well below the recommended exposure limits. To avoid high ozone concentration levels during extensive usage, install this product in a well-ventilated area and replace the ozone and exhaust filters if instructed to do so in the product maintenance instructions. If there are no references to filters in the product maintenance instructions, then it is not required to replace the filter for this product.

Please keep these safety instructions.

Precautions

Precautions before Using the Printer:

1. Read and understand all instructions;
2. Familiarize yourself with the basic principles associated with operating electrical appliances;
3. Comply with all warnings and instructions marked on the equipment or specified in the manual supplied with the equipment;
4. If the operating instructions conflict with the safety information, please refer back to the safety information, as you may have misunderstood the operating instructions. If you cannot resolve the conflicts, please call the Customer Service Hotline or contact a service representative for help;
5. Before cleaning the equipment, remove the power cord from the AC power supply outlet. Do not use liquid or aerosol cleaners;
6. Please make sure that the equipment is put on a stable desktop surface to avoid serious damage caused by the falling of the equipment;
7. Do not put the equipment near a radiator, an air conditioner, or a ventilation pipe;
8. Do not put any articles on the power cord. Do not put the equipment at the place where its power cord could be stepped on by people;
9. Outlets and extension cords must not be overloaded. This may reduce performance and could result in fire or electric shock;
10. Do not allow pets to chew on the AC power cord or the computer interface cable;
11. Do not allow sharp objects piercing equipment slot, so as to avoid contact with the high-voltage device, which otherwise may result in fire or electric shock. Take care not to spill liquids onto the equipment;
12. Do not disassemble the equipment so as to avoid the risk of electric shock. Necessary repairs may only be carried out by professional maintenance personnel. Opening or removing the cover could result in an electric shock or other potential hazards. Incorrect disassembly and assembly could also result in an electric shock during future use;
13. If any one of the following occurs, disconnect the equipment from the computer and pull out the power cord from the AC wall socket and contact a qualified member of the service personnel for maintenance:
 - Liquid has been spilled into the equipment.
 - The equipment has been exposed to rain or water.
 - The equipment falls, or the cover is damaged.
 - Significant changes in the equipment's performance.
14. Only adjust the control mentioned in the instructions. Incorrect adjustment of other controls may result in damage and mean that professional maintenance personnel need to spend more time fixing it;
15. Do not use the equipment in a thunderstorm so as to avoid the risk of an electric shock. If possible, pull out the AC power cord during a thunderstorm;
16. If you continuously print multiple pages, the surface of the tray will become very hot. Take care not to touch this surface, and keep children away from this surface;
17. The signal wire of the device connected with the printer can not be connected to the outdoors;
18. Please ensure timely ventilation in case of a prolonged use or printing huge amounts of documents in a poorly ventilated room;

-
19. In standby status, the product will automatically enter into the power saving (sleep) mode if it does not receive any job order for a while (such as 1 minute); and it can realize zero power consumption only if it has not been connected with any external input power supply;
 20. As the Class 1 equipment, the product must be connected to the power supply outlet with protective grounding line when using;
 21. This product should be placed according to the shipping marks on the product package box during delivery;
 22. This product is a kind of low-voltage equipment. When using this product below the specified voltage range, please refer to the product precautions or call Pantum Aftersales Service Centre, if the toner comes off the printed contents, or the equipment starts slowly;
 23. This product is sold as a complete machine. The consumers can go to Pantum Aftersales Service Centre to purchase parts they need. If the product sold is inconsistent with the package list, please go to the specified Aftersales Service Centre to solve the problem;
 24. Install this product in a place with the temperature between 10°C and 35°C and the relative humidity between 20% and 80%;
 25. For security and other reasons the printer may switch to intermittent printing after a certain amount of continuous printing;
 26. changes or modifications not expressly approved by the party responsible for compliance could void the user's authority to operate the equipment.
 27. The power consumption of the product with wireless function is 1.733W / without wireless function is 1.4W in networked standby if all wired network ports are connected and all wireless network ports are activated.
 28. Please keep this User Guide properly.

Legal Information



This symbol indicates that, at the end of your product's life, it must not be discarded as domestic waste. Instead, you should dispose of your used equipment at a designated collection point for the recycling of waste electrical and electronic equipment. Ref: EU Directive 2002/96/EC on Waste Electrical and Electronic Equipment (WEEE). Please contact your distributor / supplier for further information.



This product is suitable for indoor use only.



European Community (EC) directives conformity

This product complies with the protection requirements of EC directives 2014/30/EU and 2014/35/EU on the approximation and harmonization of the laws of the Member States relating to electromagnetic compatibility and safety of electrical equipment designed for use within certain voltage limits.

Radio Equipment directive 2014/53/EU only for models ending with suffix "W".

The manufacturer of this product is: Zhuhai Pantum Electronics Co.,Ltd., No.3883, Zhuhai Avenue, Zhuhai, Guangdong, China 519060.

A declaration of conformity to the requirements of the Directives is available upon request from the Authorized Representative.

This product satisfies the Class B limits of EN 55032 / EN 55035 and safety requirements of EN 62368-1.



This printer is fully compliant with the RoHS Directive 2011/65/EU for managing toxic and hazardous substances.

Table of Contents

| | |
|---|----|
| 1. Before Using the Printer | 1 |
| 1.1. Product series introduction | 1 |
| 1.2. Supplied Accessories | 2 |
| 1.3. Product View | 3 |
| 1.4. Control Panel | 5 |
| 1.4.1. Overview of control panel | 5 |
| 1.4.2. Function of power indicator | 6 |
| 2. Paper and Print Media | 7 |
| 2.1. Selecting paper | 7 |
| 2.1.1. Paper guidelines | 7 |
| 2.1.2. Paper characteristics | 7 |
| 2.1.3. Unacceptable paper | 8 |
| 2.1.4. Saving paper | 8 |
| 2.2. Paper Specification | 9 |
| 2.3. Special Paper | 10 |
| 2.4. Einlegen von Papier | 11 |
| 2.4.1. Loading into the Automatic Feeder Tray | 11 |
| 2.4.2. In manuellen Karton legen | 14 |
| 2.5. Paper and Manuscript Use Process | 15 |
| 2.5.1. Scanning With Tablet | 15 |
| 2.6. Non-printing Area and Non-scanning Area | 18 |
| 3. Driver installation and uninstallation | 19 |
| 3.1. How to install Windows printer driver | 19 |
| 3.1.1. One-click Installation | 19 |
| 3.1.2. Manual installation | 35 |
| 3.1.3. Method of driver unistallation | 43 |
| 3.2. macOS system driver installation | 43 |
| 3.2.1. Driver installation | 43 |
| 3.3. Add printer to macOS system | 47 |
| 3.3.1. Add up the printer via USB | 47 |
| 3.3.2. Add up the printer via wireline connection | 47 |
| 3.3.3. Add up the printer via wireless connection | 47 |
| 3.3.4. Add AirPrint printer | 48 |
| 4. Wired network setup (applicable to wired network models) | 49 |
| 4.1. Set IP Address | 49 |
| 4.1.1. Automatic Setting | 49 |
| 4.1.2. Manual Setting | 49 |
| 5. Wireless network setup (applicable to Wi-Fi models) | 50 |
| 5.1. Basic structure mod | 50 |
| 5.1.1. Wireless network setup tools | 50 |
| 5.1.2. Wi-Fi Protected Setup (WPS) setup | 55 |
| 5.1.3. How to disable the Wi-Fi network connected | 55 |
| 5.2. Wi-Fi Direct mode | 56 |

| | |
|--|----|
| 5.2.1. Preliminary preparations | 56 |
| 5.2.2. Wi-Fi Direct connection | 56 |
| 5.2.3. How to disable the Wi-Fi Direct | 57 |
| 5.3. Wireless network setup FAQs | 57 |
| 6. Web server | 59 |
| 6.1. Visit the embedded Web server | 59 |
| 6.2. Use Web server to manage printer..... | 59 |
| 6.2.1. IP address setup | 60 |
| 6.2.2. Wireless setup | 61 |
| 6.2.3. Machine setup..... | 62 |
| 6.2.4. Recover factory settings via Web server | 65 |
| 7. Print | 66 |
| 7.1. Print Function..... | 66 |
| 7.2. Print Settings | 68 |
| 7.2.1. Setting the printing parameters | 68 |
| 7.2.2. Print quality settings | 68 |
| 7.2.3. Duplex | 72 |
| 7.2.4. Booklet printing | 75 |
| 7.2.5. Set transfer print parameters..... | 76 |
| 7.2.6. Open Help Document..... | 77 |
| 7.3. Printing Mode..... | 78 |
| 7.3.1. Printing with the Automatic Feeder Tray..... | 78 |
| 7.3.2. Printing with manual feed tray | 79 |
| 7.4. Cancel printing..... | 79 |
| 8. Copying..... | 80 |
| 8.1. Copying function | 80 |
| 8.2. Copying method..... | 80 |
| 8.3. Common copying setting..... | 81 |
| 8.3.1. Image quality | 81 |
| 8.3.2. Intensity | 81 |
| 8.3.3. Resizing | 81 |
| 8.3.4. Multipage | 82 |
| 8.3.5. Clone | 83 |
| 8.3.6. Poster | 83 |
| 8.3.7. Duplex copy | 84 |
| 8.4. ID copy settings | 86 |
| 8.4.1. Arrangement mode | 87 |
| 8.4.2. Intensity | 88 |
| 8.4.3. Paper dimension | 88 |
| 8.5. Receipt setting | 88 |
| 8.5.1. Intensity | 88 |
| 8.5.2. Paper dimension | 88 |
| 8.6. Copying cancel | 88 |
| 9. Scan | 89 |
| 9.1. Scanning mode..... | 89 |
| 9.1.1. Windows system scan..... | 89 |

| | |
|---|-----|
| 9.1.2. macOS System Scan | 97 |
| 9.1.3. Push Scan | 101 |
| 9.2. Cancel scanning | 102 |
| 10. Mobile Print/Scan (for models with WiFi function only) | 103 |
| 10.1. "Pantum" APP | 103 |
| 10.1.1. Operating systems supported | 103 |
| 10.1.2. How to download Pantum App | 103 |
| 10.1.3. How to use this "Pantum" APP | 103 |
| 10.2. Mopria mobile print..... | 104 |
| 10.2.1. The operating systems and applications which support Mopria mobile printing . | 105 |
| 10.2.2. How to download Mopria Print Service..... | 105 |
| 10.2.3. Preliminary preparations | 105 |
| 10.2.4. How to use Mopria mobile printing | 105 |
| 10.3. AirPrint mobile print..... | 106 |
| 10.3.1. Operating systems supported by AirPrint mobile print | 106 |
| 10.3.2. Preliminary preparations | 106 |
| 10.3.3. How to use AirPrint mobile printing | 106 |
| 11. General Settings | 107 |
| 11.1. System Setting..... | 107 |
| 11.1.1. Language Setting..... | 107 |
| 11.1.2. Sleep Time Setting..... | 108 |
| 11.1.3. Ink saving setting | 109 |
| 11.1.4. Restore Factory Settings..... | 109 |
| 11.1.5. Mute printing | 110 |
| 11.1.6. Auto shut-off setting | 111 |
| 11.1.7. Panel energy saving settings | 112 |
| 11.2. Print Settings..... | 113 |
| 11.2.1. Print Density..... | 113 |
| 11.2.2. Color Calibration | 114 |
| 11.2.3. Transfer Print Settings | 115 |
| 11.3. Network Settings..... | 115 |
| 11.4. Network Information | 116 |
| 11.5. Online upgrade | 116 |
| 11.6. Information report..... | 117 |
| 11.7. Consumable information | 118 |
| 12. Routine Maintenance | 119 |
| 12.1. Cleaning the Printer | 119 |
| 12.1.1. Please use mild detergents..... | 120 |
| 12.2. Replacing parts and consumables | 121 |
| 12.2.1. Replacing the toner cartridge | 122 |
| 12.2.2. Replacing the waste toner bottle | 125 |
| 12.2.3 Replace the tray..... | 126 |
| 12.3. Move the printer | 127 |
| 12.3.1. Move the printer to another location | 127 |
| 12.3.2. Transporting the printer | 128 |
| 11.1.7. Panel energy saving settings | 129 |

| | |
|--|-----|
| 11.2. Print Settings..... | 130 |
| 11.2.1. Print Density..... | 130 |
| 11.2.2. Color Calibration | 131 |
| 11.2.3. Transfer Print Settings | 132 |
| 11.3. Network Settings..... | 133 |
| 11.4. Network Information | 133 |
| 11.5. Online upgrade | 134 |
| 11.6. Information report..... | 135 |
| 11.7. Consumable information | 136 |
| 13. Troubleshooting | 137 |
| 13.1. Avoiding jams..... | 137 |
| 13.1.1. Correct loading of paper..... | 137 |
| 13.1.2. Use recommended paper..... | 138 |
| 13.2. Locate jammed paper | 139 |
| 13.3. Cleaning Jammed Paper..... | 140 |
| 13.3.1. Paper jam in the automatic tray..... | 140 |
| 13.3.2. Paper jam in the manual tray | 142 |
| 13.3.3. Paper jam in the rear cover | 143 |
| 13.4. Software Failure..... | 146 |
| 13.5. Error Message | 147 |
| 13.6. Common Troubleshooting | 148 |
| 13.6.1. Common Problems | 148 |
| 13.6.2. Image Defects..... | 150 |
| 14. Product Specifications..... | 156 |
| 14.1. Overview of the Specifications | 156 |
| 14.2. Print Specifications..... | 157 |
| 14.3. Copy Specifications..... | 157 |
| 14.4. Scan Specifications..... | 157 |

1. Before Using the Printer







1.1. Product series introduction

| Product series parameters | | CM1100DN Series | CM1100DW Series |
|---------------------------|------------------------------|-----------------|-----------------|
| Interface type | USB | ● | ● |
| | NET | ● | ● |
| | Wi-Fi | | ● |
| Print Language | PDL | ● | ● |
| Control Panel | LCD | ● | ● |
| Print Speed | A4 18ppm | ● | ● |
| | Letter 19ppm | ● | ● |
| Printing function | Automatic Two-Sided Printing | ● | ● |
| | Color Printing | ● | ● |
| Copy | Manual duplex copy | ● | ● |
| | Color Copy | ● | ● |
| Scan | Chromoscan | ● | ● |
| Tablet (FB) | | ● | ● |

(●: Support; Blank: Unsupport)

 **Note:** • This product series is subject to additions or changes without prior notice.

1.2. Supplied Accessories

| Name | Parts |
|-----------------------|--|
| Laser Toner Cartridge |  |
| Waste toner bottle |  |
| USB Interface Cable |  |
| Power Cord |  |
| CD |  |
| Quick Setup Guide |  |
| Pantum Warranty |  |

 **Note:** • The Pantum Warranty may not be attached in some regions.

1.3. Product View

Side view

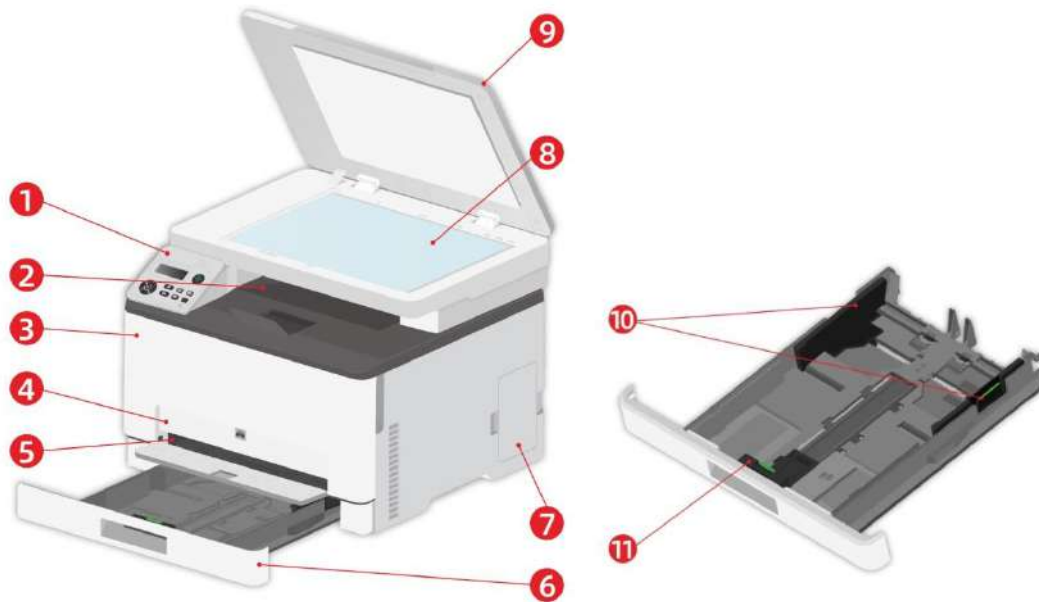

| | | |
|----|--|--|
| 1 | Control Panel | Indicate printer status to conduct set operation. |
| 2 | Standard exit | For storing the printed paper. |
| 3 | Front Cover | To open the front cover to take out the laser toner cartridge. |
| 4 | Manual feed tray | For placing mediums that are printed in manual feed tray. |
| 5 | Manual tray width guide | Slide paper deflector to adapt to paper width. |
| 6 | Automatic Feeder Tray | For placing mediums that are printed in auto feed tray. |
| 7 | Waste toner bottle | Store the waste toner produced in printing. |
| 8 | Glass Platen | To put the original of tablet PC for scan. |
| 9 | Cover of scanner | Open the cover of scanner to place the scanned originals on its glass plate. |
| 10 | Paper width deflector of auto feed tray | Slide paper deflector to adapt to paper width. |
| 11 | Paper length deflector of auto feed tray | Slide paper length deflector to adapt to paper length. |

 **Note:** • Printer appearance may vary depending on the printer model and configuration; the schematic diagram is for reference only.

Rear View



: To avoid the risk of electrical shock, do not set up this product or make any electrical or cabling connections during a lightning storm.



: To avoid the risk of fire or electrical shock, connect the power cord to an appropriately rated and properly grounded electrical outlet that is near the product and easily accessible.



: Do not cut, twist, bind, crush, or place heavy objects on the power cord. Do not subject the power cord to abrasion or stress. Do not pinch the power cord between objects such as furniture and walls. If any of these things happen, it could result in a risk of fire or electrical shock. Inspect the power cord regularly for signs of such problems. Remove the power cord from the electrical outlet before inspecting it.



: To avoid the risk of electrical shock, make sure that all external connections (such as Ethernet) are properly installed in their marked plug-in ports.



: To avoid the risk of fire or electrical shock, use only the power cord provided with this product or the manufacturer's authorized replacement.



Note:• To avoid loss of data or printer malfunction, do not touch the USB cable, any wireless network adapter, or the printer in the areas shown in the printing process.

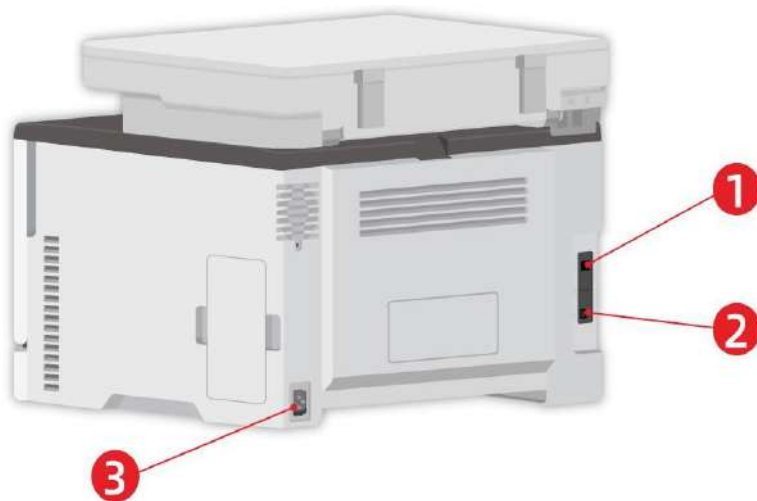

| | | |
|---|---|---|
| 1 | Network Interface(applicable to models supporting network function) | For connecting product to network with network cable. |
| 2 | USB Interface | For connecting product to computer with USB cable. |
| 3 | Power Interface | For connecting product to power with power cord. |

 **Note:** • Printer appearance may differ because of various models and functions, so the schematic diagram is only for your reference.

1.4. Control Panel

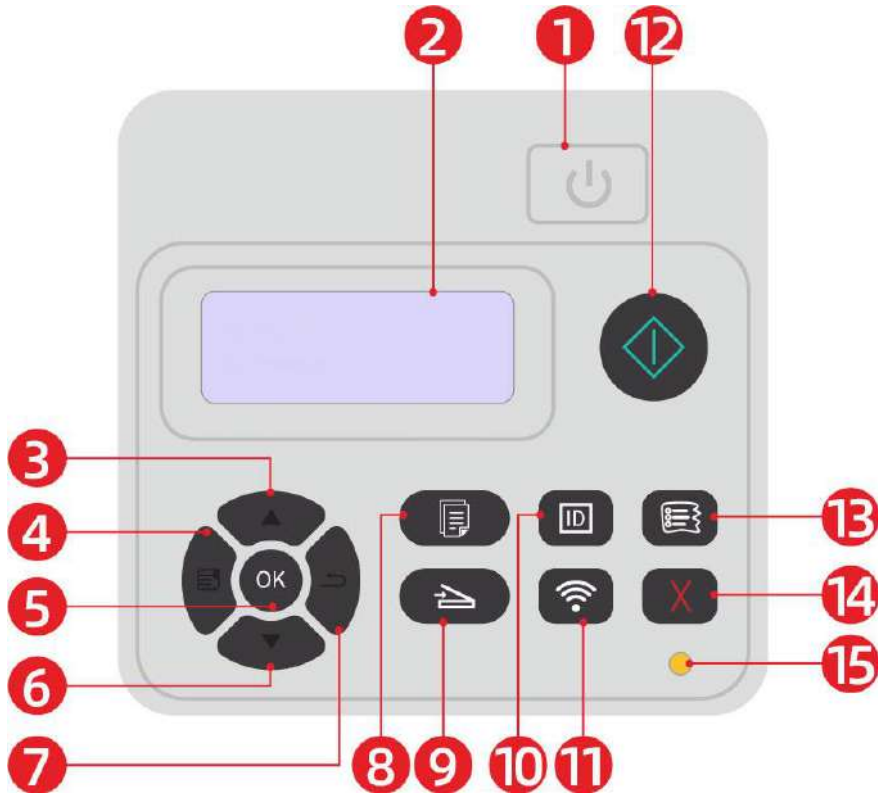

1.4.1. Overview of control panel



| No. | Name | Functions |
|-----|--------------|---|
| 1 | Power switch | Turn the power on or off and press this button under Ready state to enter energy-saving mode. Press and hold this button for more than 2s to turn the printer power off. |
| 2 | LCD Display | • Display operation interface and product information. |
| 3 | UP | • Scroll through the menus and options. • Increase 1 copy on the ready interface of Copy mode. |
| 4 | Menu | • Open the main menu of control panel |
| 5 | OK | • Confirm the selection on screen. |
| 6 | Down | • Scroll through the menus and options. • Decrease 1 copy on the ready interface of Copy mode. |
| 7 | Back | • Return to the previous menu. |
| 8 | Copy Button | • Press this button to enter into copy mode. |

| | | |
|----|------------------|--|
| 9 | Scan Button | <ul style="list-style-type: none"> • Press this button to enter into scan mode. |
| 10 | ID copy | <ul style="list-style-type: none"> • Press it to enter the ID copy mode. |
| 11 | Wi-Fi button | <ul style="list-style-type: none"> • Short press Wi-Fi button to turn on direct Wi-Fi connection of the printer and automatically print out "Mobile Device Wi-Fi Connection Wizard" page (for models with Wi-Fi function only). • Long press Wi-Fi button for over 2s to start WPS when Wi-Fi is not connected or to disconnect Wi-Fi when it has already been connected (for models with Wi-Fi function only). • Open save toner function(applicable to non-Wi-Fi model only). |
| 12 | Start Button | <ul style="list-style-type: none"> • This is used to start relevant operations after finishing operation settings. • In case of a feed failure, please press this key for pick-up and printing again. |
| 13 | Bill Copy Button | <ul style="list-style-type: none"> • Press this button to enter into Bill Copy mode. |
| 14 | Cancel | <ul style="list-style-type: none"> • Execute cancel operation. • Idle state interface under copy mode, to reset the "Number of Copies" to 01. |
| 15 | Status Light | <ul style="list-style-type: none"> • Indicate the status of printer. |

1.4.2. Function of power indicator

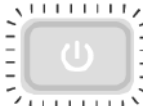
| No. | Status displayed by power indicator | Status | Status Description |
|-----|---|-----------|---|
| 1 |  | Die out | The printer is powered off. |
| 2 |  | Always on | Printer is not in sleep state (printer ready, printing, processing, etc). |
| 3 |  | Blink | The printer is in sleep state. |

2. Paper and Print Media

2.1. Selecting paper

2.1.1. Paper guidelines

Use appropriate paper to prevent paper jam and ensure trouble-free printing.

- It is recommended to use new, undamaged paper.
- Before loading paper, know the recommended printable side of the paper. This information is usually indicated on the paper package.
- Do not use paper that has been cut or trimmed by hand.
- Do not mix paper sizes, types, or weights in the same tray; mixed use can cause paper jams.
- Do not use coated paper unless they are specifically designed for electrophotographic printing.

2.1.2. Paper characteristics

The following paper characteristics affect print quality and reliability. Consider these factors before printing.

Weight

The tray can feed grain long paper with a weight of 60-200 g/m². Paper lighter than 60 g/m² may not be stiff enough to feed properly, and may cause paper jams.

Curl

Curl is the tendency of paper to curl at its edges. Excessive curl can cause paper feeding problems. Curl can occur after the paper passes through the printer, where it is exposed to high temperatures. Storing paper unpacked in hot, humid, cold, or dry conditions can contribute to paper curling before printing and can cause feeding problems.

Smoothness

Paper smoothness directly affects print quality. If paper is too rough, toner cannot fuse to it properly. If paper is too smooth, it can cause paper feeding or print quality problems.

Moisture content

The amount of moisture in paper affects both print quality and the printer ability to feed the paper correctly. Leave paper in its original wrapper until you use it. Change in the moisture content caused by paper exposure can degrade its performance.

Store paper in its original wrapper in the same environment as the printer for 24 to 48 hours before printing. Extend the time several days if the storage or transportation environment is very different from the printer environment. Thick paper may also require a longer conditioning period.

Grain direction

Grain refers to the alignment of the paper fibers in a sheet of paper. Grain is either grain long, running the length of the paper, or grain short, running the width of the paper. For 60-200 g/m² paper, grain long paper is recommended.

Fiber content

Most high-quality xerographic paper is made from 100% chemically treated pulped wood. This content provides the paper with a high degree of stability, leading to fewer paper feeding problems and better print quality. Paper containing fibers such as cotton can negatively affect paper handling.

2.1.3. Unacceptable paper

The following paper types are not recommended for use with the printer:

- Chemically treated paper used to make copies without carbon paper, also known as carbonless papers, carbonless copy paper (CCP), or no carbon required (NCR) paper.
- Preprinted paper with chemicals that may contaminate the printer.
- Preprinted paper that can be affected by the temperature in the printer fuser.
- Preprinted paper that require a positioning accuracy (the precise print location on the page) greater than ± 2.3 mm, such as optical character recognition (OCR) forms. In some cases, you can use software applications to adjust the positioning to successful
- Coated paper (erasable bond paper), synthetic paper, thermal paper.
- Rough-edged, rough or heavily textured surface paper, or curled paper.
- Paper weighing less than 60 g/m².
- Multiple-part forms or documents.

2.1.4. Saving paper

Use these paper storage guidelines to help avoid jams and uneven print quality:

- Store paper in its original wrapper in the same environment as the printer for 24 to 48 hours before printing.
- Extend the time several days if the storage or transportation environment is very different from the printer environment. Thick paper may also require a longer conditioning period.
- For best results, store paper where the temperature is 21°C and the relative humidity is 40%.
- Most label manufacturers recommend printing in an environment with a temperature of 18-24 °C and a relative humidity of 40~60%.
- Store paper in cartons, on a pallet or shelf, rather than on the floor.
- Store individual packages on a flat surface.
- Do not store anything on top of individual paper packages.
- Take paper out of the carton or wrapper only when you are ready to load it in the printer. The carton and wrapper help keep the paper clean, dry, and flat.

2.2. Paper Specification

| | | |
|-----------------------|------------------------------|--|
| Automatic Feeder Tray | Media Type | Plain paper(70~105g/m ²),thin paper(60~70g/m ²) |
| | Media size | A4,A5, A6,Legal,Letter,JIS-B5, ISO B5, Executive , Folio , Oficio , Statement ,16K,32K, Big 16K, Big 32K, B6,Customize paper. |
| | Media weight | 60~105 g/m ² |
| | Maximum capacity of the tray | 250 pages (80 g/m ²) 。 |
| Manual feed tray | Media Type | Plain paper(70~105g/m ²),thin paper(60~70g/m ²),thick paper(105~200g/m ²),transparent film,carton paper,label paper, envelope |
| | Media size | A4, A5, A6, Legal, Letter, JIS-B5, ISO B5, Executive , Folio , Oficio , Statement ,16K,32K, Big 16K, Big 32K, No.10 Env., Monarch Env, DL Env, C5 Env, C6 Env, ZL, Janpanese Postcard, Yougata4, Younaga3, Nagagata3, Yougata2, Postcard, B6, Customize paper. |
| | Media weight | 60~200 g/m ² |
| | Maximum capacity of the tray | 1 pages |



Note: • 80 g/m² standard paper is recommended for this printer.

- It is not recommended to use special paper extensively, which may affect the service life of the printer.
- The print media that does not meet the guidelines listed in this User Guide may result in poor print quality, increased paper jam and excessive wear of the printer.
- Properties such as weight, composition, texture and humidity are important factors affecting the printer performance and output quality.

Please note the following matters when selecting the print media:

1. Desired print effect: The print media selected should meet the requirement of the print tasks.
2. Surface smoothness: The smoothness of the print media may affect the sharpness of the print outcome.
3. Some print media may meet all the use guidelines contained herein, but they still can not bring satisfactory effect. This may be due to incorrect operation, inappropriate temperature and humidity, or other factors beyond the control of Pantum. Before purc

2.3. Special Paper

This printer supports using the special paper for printing. Special paper includes: label paper, envelope, transparent film, thick paper, carton paper, thin paper.



Note: • When using special paper or print media, be sure to select matched print type and size in the print settings so as to get the best print effect.

Please observe the following standards:

| Types of Print Media | Correct Practices | Incorrect Practices |
|---------------------------|--|---|
| Label Paper | <p>Use labels with no exposed lining paper only.</p> <p>Labels shall be put flat when using.</p> <p>Use labels of full sheet only.</p> <p>There is no guarantee that all the labels in the market can meet corresponding requirements.</p> | <p>Use wrinkled, blistered or damaged label papers.</p> |
| Envelope | <p>Envelopes should be loaded evenly.</p> | <p>Use wrinkled, nicked, stuck or damaged envelopes.</p> <p>Use envelopes with clips, snaps, windows, or coated linings.</p> <p>Use envelopes with self-adhesive stickers or other synthetic materials.</p> |
| Transparent Film | <p>Only use transparent films approved for use in laser printers.</p> | <p>Use transparent print media that is not suitable for laser printers.</p> |
| Thick Paper, carton paper | <p>Only use heavy paper that is approved for use in laser printers and meets the weight specifications of this printer.</p> | <p>Use the paper whose weight is more than the specification of the media recommended for this printer, unless the paper is approved for use in this printer.</p> |

2.4. Einlegen von Papier

 **Note:** • Druckeraussehen konnte unterschiedlich wegen seine Modelle sein. Die schematische Darstellung ist nur zum Informationszwecken.

2.4.1. Loading into the Automatic Feeder Tray



: To avoid the risk of electrical shock, if you are accessing the controller board or installing optional hardware or memory devices after setting up the printer, turn the printer off, and unplug the power cord from the electrical outlet before continuing. |



: To reduce the risk of equipment instability, load each tray separately. Keep all other trays closed until needed.

1. Slide out the automatic feeder tray from the printer.



 **Note:** • To avoid paper jams, do not remove the tray while the printer is busy.

2. Flex, fan out and align the paper edges before loading.

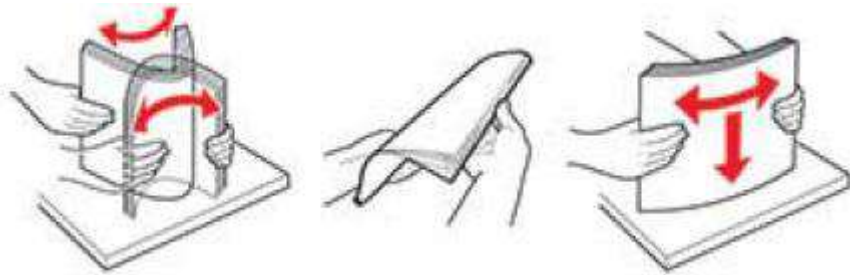

3. Load the paper with the printable side facing up.



 **Note:** • For single-sided printing, load the paper with the printing side facing up and the header facing the inside of the tray.

- Do not slide paper into the tray.
 - To avoid paper jams, make sure that the stack height is below the maximum paper fill indicator.
-

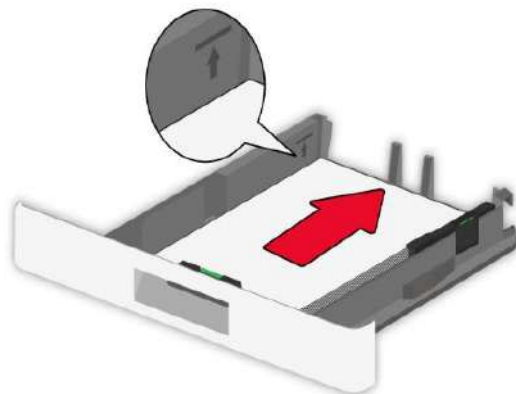

4. Adjust the guide to match the size of the loaded paper.

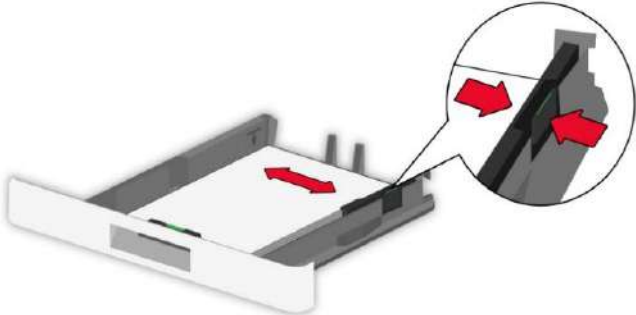
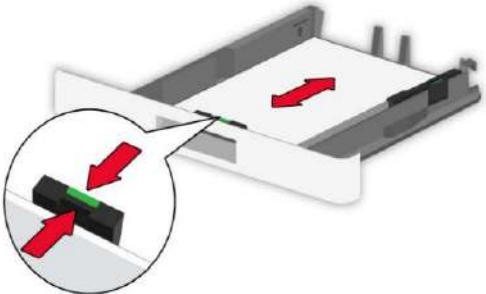

5. Insert the tray.

2.4.2. In manuellen Karton legen

1. Adjust the guide to match the size of the loaded paper.



2. Load a sheet of paper with the printable side facing up.

-
-  **Note:** • For single-sided printing, load the paper with the printable side facing up and the top edge going into the printer first.
- For better printing effect, it is recommended to use new, undamaged paper.
-



3. Feed the paper until its front edge is pulled in.

-
-  **Note:** • To avoid paper jams, do not force paper into the manual tray.
-

2.5. Paper and Manuscript Use Process

Manuscript requirements:

| Source | Type | Size |
|--------|------|---|
| Platen | — | A4, A5, A5L, A6, Executive, JIS B5, Letter, Full Platen, Custom |

2.5.1. Scanning With Tablet



Note: • Druckeraussehen konnte unterschiedlich wegen seine Modelle sein. Die schematische Darstellung ist nur zum Informationszwecken.

Steps of Use:

1. Lift up the scanner cover.



2. Load the manuscript face down.

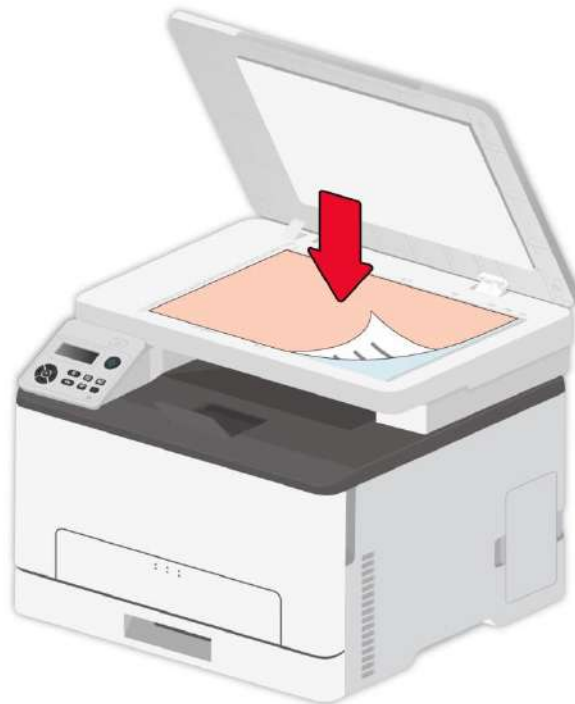

3. Align the manuscript to match the appropriate paper size.

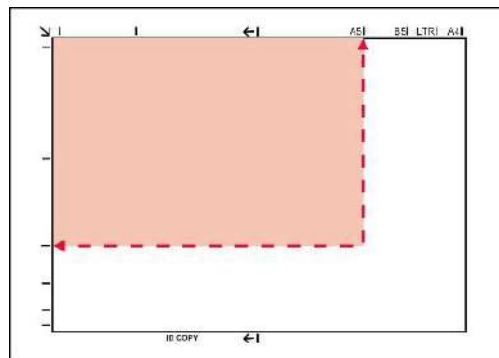

 **Note:** • If the manuscript does not match with any size marker, please align the upper-left corner of the manuscript with the arrow.

- Make sure there is no document in the ADF. If a document is detected in the ADF, it will be more preferential than that on glass platen.
-

4. Close the scanner cover gently.



-
-  **Note:** • Please put the paper or document on the scanner glass after the glue, ink or correction fluid are completely dried.
- Rough textured, uneven, oil stained and extremely smooth paper will make printing effect poor.
 - Please make sure that there is no dust, fluff, etc. on the paper.
 - Paper shall be put on a flat surface and stored under a cool and dry environment.
 - To avoid influencing the definition, please don't open the scanner cover during scanning with the platen.
-

2.6. Non-printing Area and Non-scanning Area

The shaded part indicates the non-printing area and non-scanning area.

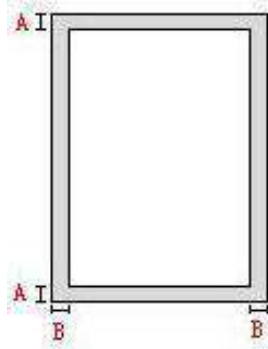

| Usage | Paper Size | Top and bottom margins (A) | Left and right margins (B) |
|----------|------------|----------------------------|----------------------------|
| Printing | A4 | 5mm(0.197inch) | 5mm(0.197inch) |
| | Letter | 5mm(0.197inch) | 5mm(0.197inch) |
| Scan | A4 | 5mm(0.197inch) | 5mm(0.197inch) |
| | Letter | 5mm(0.197inch) | 5mm(0.197inch) |

3. Driver installation and uninstallation

3.1. How to install Windows printer driver

Windows driver installation software provides two installing methods: one-click installation and manual installation. We recommend one-click installation, which can help to install driver automatically in a faster and more convenient way. If you have any difficulty in using one-click installation, please try manual installation.



Note: • Driver installation interface may differ because of different models and functions, so the schematic diagram is only for your reference.

3.1.1. One-click Installation

One-click installation provides three methods of installation: connect the printer via USB cable, connect the printer via wired network, and connect the printer via wireless network. You can choose one of them according to your habit.

3.1.1.1. Method I: Connect the printer via USB cable

1. Connect the printer to computer via USB cable, power the printer and computer on.
2. Place the attached installation CD in the computer CD-ROM:
 - Windows XP system: automatically run the installation procedure.
 - Windows 7/Vista/Server 2008 system: Pop up "Autoplay" interface, click "Autorun.exe" to run the installation procedure.
 - Windows 8 system: When the "DVD RW driver" window pops up from the right top corner of Computer desktop, click anywhere in the pop-up window, then click "Autorun.exe" to run the installation program.
 - Windows 10 system: When the "DVD RW driver" window pops up from the lower right corner of Computer desktop, click anywhere in the pop-up window, then click "Autorun.exe" to run the installation program.



Note: • Some computers may be unable to auto play the CD because of system configuration. Please double click "Computer" icon, find "DVD RW driver", then double click "DVD RW driver" to run the installation procedure.

3. Read and agree to the terms contained in the End User License Agreement and the Privacy Policy, click the "Next" button in the lower right corner of the interface to enter the driver installation interface.

4. Click on the "One-click installation" button in Method I and enter into the installation process. The process may need some time, and the duration is related to your computer configuration, please wait patiently.

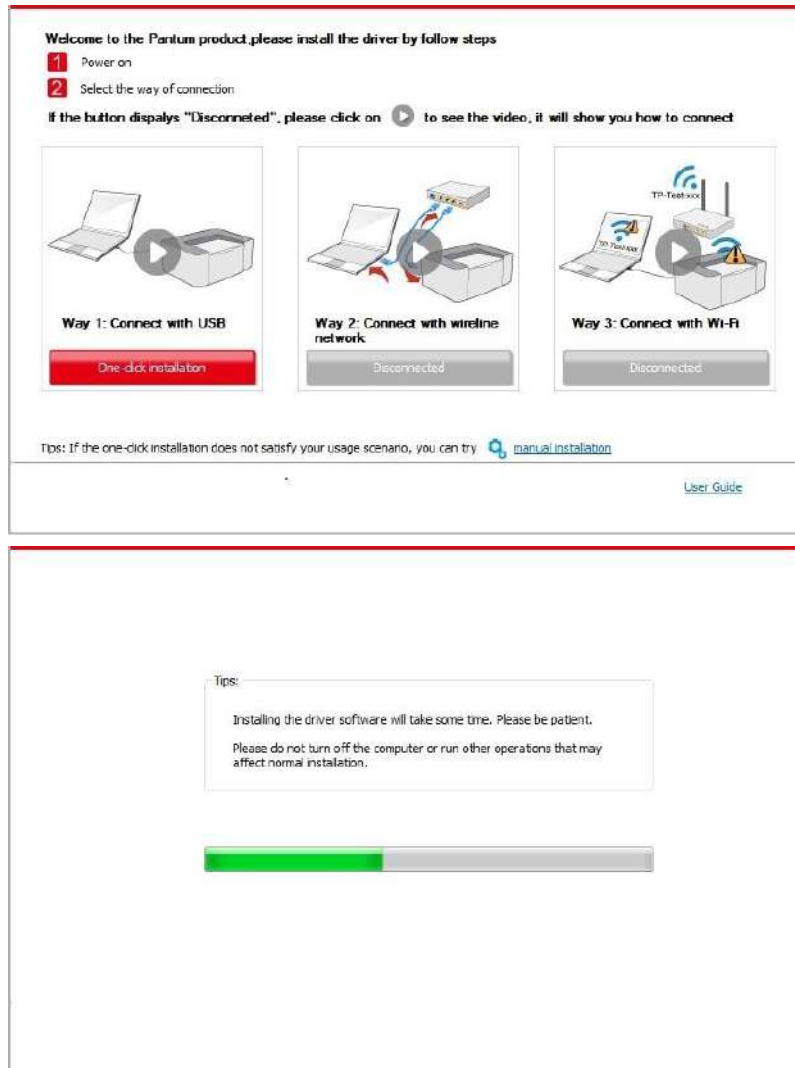

5. After the installation, click "Print & Test Page" button. If your printer prints the test page successfully, it means that you have installed the driver correctly.

3.1.1.2. Method II: Connect the printer via wired network

1. Turn the power of printer and computer on.
2. Connect the computer to wired network.
3. Connect network cable to the network interface of printer, to make sure the printer is connected to computer network (please refer to [Chapter 4](#) for network setup).
4. Place the attached installation CD in the computer CD-ROM:
 - Windows XP system: automatically run the installation procedure.
 - Windows 7/Vista/Server 2008 system: Pop up "Autoplay" interface, click "Autorun.exe" to run the installation procedure.
 - Windows 8 system: When the "DVD RW driver" window pops up from the right top corner of Computer desktop, click anywhere in the pop-up window, then click "Autorun.exe" to run the installation program.
 - Windows 10 system: When the "DVD RW driver" window pops up from the lower right corner of Computer desktop, click anywhere in the pop-up window, then click "Autorun.exe" to run the installation program.



Note: • Some computers may be unable to auto play the CD because of system configuration. Please double click "Computer" icon, find "DVD RW driver", then double click "DVD RW driver" to run the installation procedure.

5. Read and agree to the terms contained in the End User License Agreement and the Privacy Policy, click the "Next" button in the lower right corner of the interface to enter the driver installation interface.
6. Please click on the "One-click installation" button in Method II and install driver software.



Note: • You can put your mouse cursor in the "One-click installation" button to check the popup information in order to confirm if the current printer is the one you need to install through IP address before you click the button.



- You can check the printer IP address through "Network configuration page" (Please see [Chapter 11.6](#) for how to print)

- Click on the "One-click installation" button to enter installation process if your software has searched only one printer. The process may need some time, and the duration is related to your computer configuration. Please wait patiently.

Welcome to the Pantum product, please install the driver by follow steps

- 1 Power on
- 2 Select the way of connection

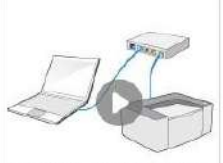
If the button displays "Disconnected", please click on  to see the video, it will show you how to connect

| | | |
|---|--|--|
|  Way 1: Connect with USB Disconnected |  Way 2: Connect with wireline network One-click installation |  Way 3: Connect with Wi-Fi Disconnected |
|---|--|--|

Tips: If the one-click installation does not satisfy your usage scenario, you can try [manual installation](#)

[User Guide](#)

Tips:

Installing the driver software will take some time. Please be patient.
Please do not turn off the computer or run other operations that may affect normal installation.



- If your software has searched several printers, click on the "One-click installation" button, and the printer list interface will pop up. Please select the printer that you need according to your printer wired network IP address or host ID.

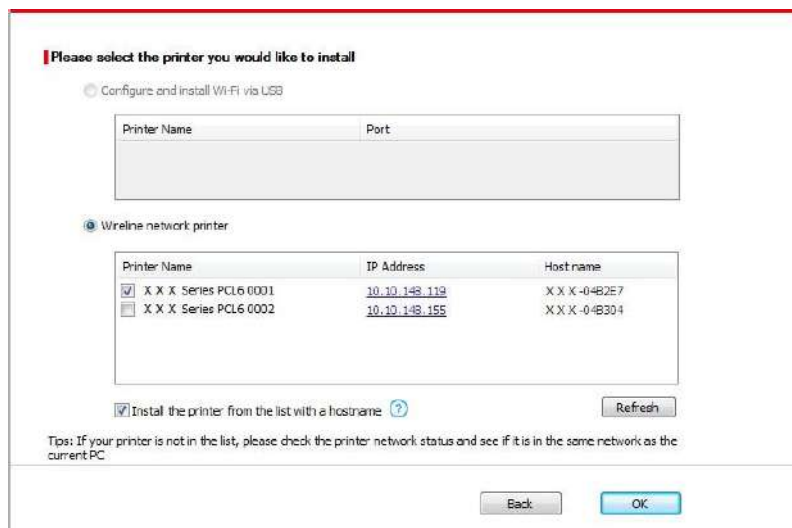
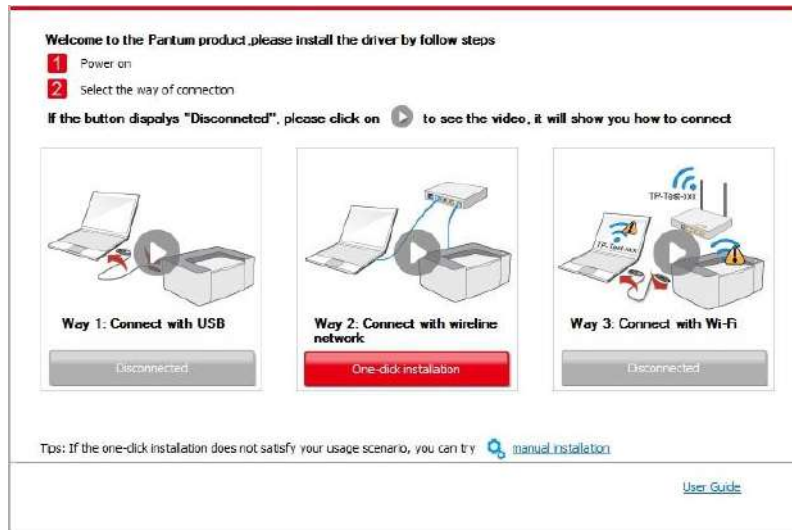

Note: • If the printer you need is not shown in the list, please click "Refresh" button to search again. If it is not found, please check if the printer and computer are in the same network. (Please see [Chapter 5.3](#) for how to check).

- When the printer IP address changes under printer name driver installed with host ID , you can also directly print without re-installing the driver. If you need to install the printer driver with the host ID, please check the option "Install the printer in the list with host ID".

7. After the installation, click "Print & Test Page" button. If your printer prints the test page successfully, it means that you have installed the driver correctly.

3.1.1.3. Method III: Connect the printer via wireless network

Please check if the printer is connected with wireless network when installing the printer driver software. If disconnected, please install it with reference to [Chapter 3.1.1.3.1](#). If connected, please install it with reference to [Chapter 3.1.1.3.2](#).



Note: • You can print "Network configuration page" to confirm printer network connection status to see if printer is connected with network (Please see [Chapter 11.6](#) for how to print).

3.1.1.3.1. The printer is not connected with wireless network

3.1.1.3.1.1. Configure wireless network via USB cable and install driver

Since some computers are not provided with wireless network function, this section is divided into "Connect computer to router via Wi-Fi" and "Connect computer to router via wired connection" to introduce installation process.

I. Connect computer to router via Wi-Fi

1. Computer is already connected to router via Wi-Fi.
2. Connect the printer to computer via USB cable, then power the printer on.
3. Place the attached installation CD in the computer CD-ROM:
 - Windows XP system: automatically run the installation procedure.
 - Windows 7/Vista/Server 2008 system: Pop up "Autoplay" interface, click "Autorun.exe" to run the installation procedure.
 - Windows 8 system: When the "DVD RW driver" window pops up from the right top corner of Computer desktop, click anywhere in the pop-up window, then click "Autorun.exe" to run the installation program.
 - Windows 10 system: When the "DVD RW driver" window pops up from the lower right corner of Computer desktop, click anywhere in the pop-up window, then click "Autorun.exe" to run the installation program.



Note: • Some computers may be unable to auto play the CD because of system configuration. Please double click "Computer" icon, find "DVD RW driver", then double click "DVD RW driver" to run the installation procedure.

4. Read and agree to the terms contained in the End User License Agreement and the Privacy Policy, click the "Next" button in the lower right corner of the interface to enter the driver installation interface.

5. Click the "One-click installation" button in Method III to install driver software.



Note: • You can put your mouse cursor in the "One-click installation" button to check the popup information in order to confirm if the current printer is the one you need to install through IP address before you click the button.

- You can check the printer IP address through "Network configuration page" (Please see [Chapter 11.6](#) for how to print)

- Click "One-click installation" button if your software has searched only one printer, and enter into installation process to complete automatic network configuration and driver installation.

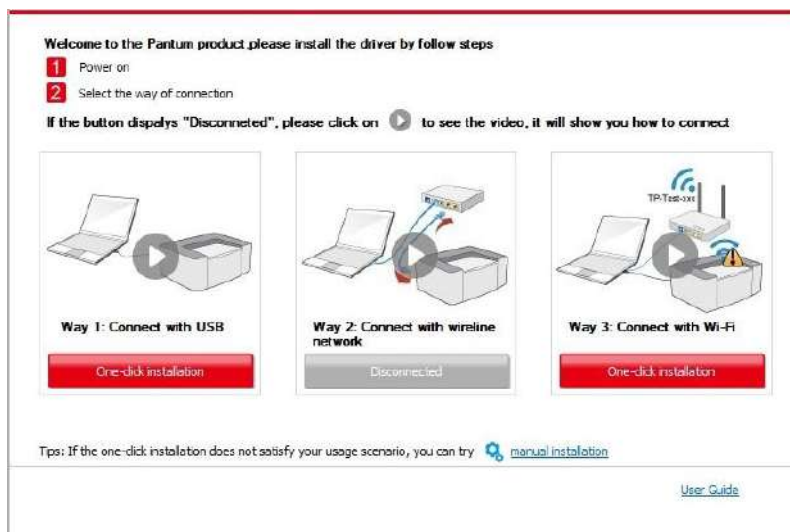

- If your software has searched several printers, click "One-click installation" button, and the printer list interface will pop up. Please select "Configure printer with Wi-Fi via USB and install" and select USB printer, click "Confirm" button and enter into installation process to complete automatic network configuration and driver installation.

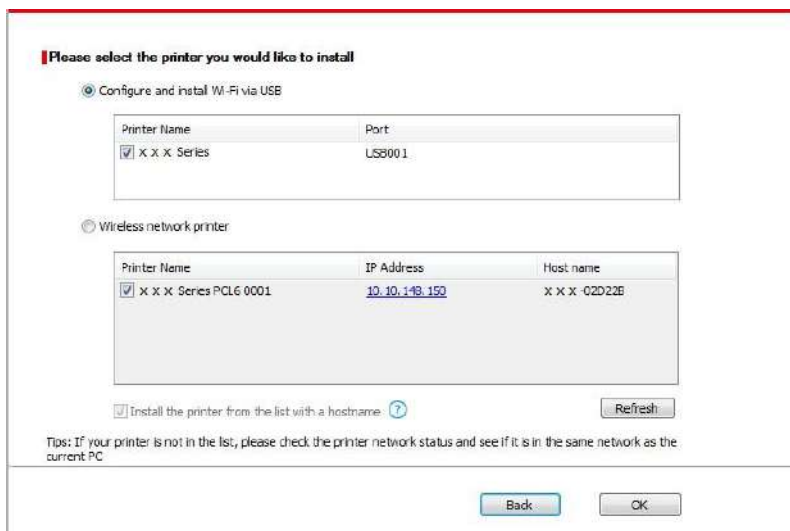
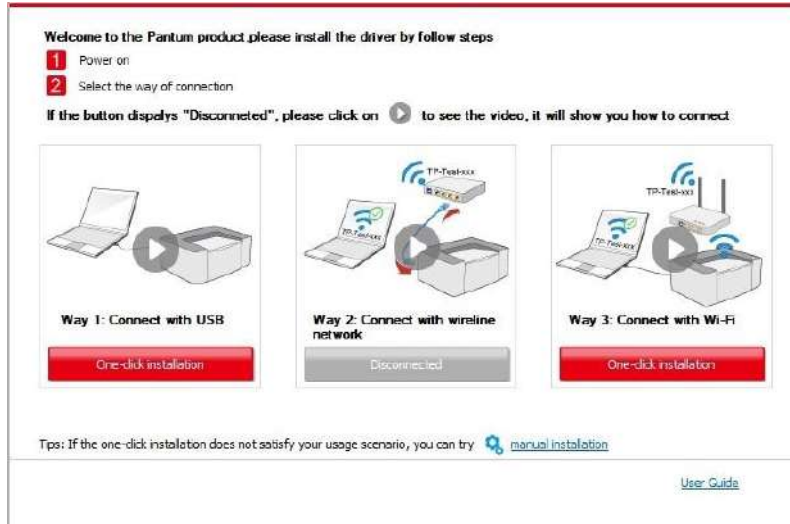

Note: • When the printer IP address changes under printer driver installed with host ID , you can also directly print without re-installing the driver. If you need to install the printer driver with the host ID, please check the option "Install the printer in the list with host ID".

6. After the installation, click "Print & Test Page" button. If your printer prints the test page successfully, it means that you have installed the driver correctly.

II. Connect computer to router via network cable

1. Connect computer to router via network cable.
2. Connect the printer to computer via USB cable, then power the printer on.
3. Place the attached installation CD in the computer CD-ROM:
 - Windows XP system: automatically run the installation procedure.
 - Windows 7/Vista/Server 2008 system: Pop up "Autoplay" interface, click "Autorun.exe" to run the installation procedure.
 - Windows 8 system: When the "DVD RW driver" window pops up from the right top corner of Computer desktop, click anywhere in the pop-up window, then click "Autorun.exe" to run the installation program.
 - Windows 10 system: When the "DVD RW driver" window pops up from the lower right corner of Computer desktop, click anywhere in the pop-up window, then click "Autorun.exe" to run the installation program.



Note: • Some computers may be unable to auto play the CD because of system configuration. Please double click "Computer" icon, find "DVD RW driver", then double click "DVD RW driver" to run the installation procedure.

4. Read and agree to the terms contained in the End User License Agreement and the Privacy Policy, click the "Next" button in the lower right corner of the interface to enter the driver installation interface.
5. Please click on the "One-click installation" button in Method III and install driver software.



Note: • You can put your mouse cursor in the "One-click installation" button to check the popup information in order to confirm if the current printer is the one you need to install through IP address before you click the button.

- You can check the printer IP address through "Network configuration page" (Please see [Chapter 11.6](#) for how to print).

- Click on the "One-click installation" button if your software has only searched only one printer, and the wireless network configuration interface will pop up, input the SSID and password that you need, then click "Confirm" button, and enter into installation process. The process may need some time, and the duration is related to your computer configuration, please wait patiently.

Welcome to the Pantum product please install the driver by follow steps

- 1 Power on
- 2 Select the way of connection

If the button displays "Disconnected", please click on  to see the video, it will show you how to connect



Way 1: Connect with USB

One-click installation



Way 2: Connect with wireline network

Disconnected



Way 3: Connect with Wi-Fi

One-click installation

Tips: If the one-click installation does not satisfy your usage scenario, you can try [manual installation](#)

[User Guide](#)

1. Please click on "Printing wireless network information page" to get the network name and encryption method. Please skip this step if you already know the network name and encryption method.

[Printing wireless network information page](#)

2. Please enter wireless network user name and password.

Network Name(SSID):

Encryption method:

Password:

Show password:

- If your software has searched more than one printers, the printer list interface will pop up. You need to configure the current printer which is connected via USB cable to wireless network and install driver. Please select "Configure the print via USB and install" on the printer list interface and check the USB printer option. Click the "Confirm" button, and the wireless network configuration interface will pop up. Input the wireless SSID and password that you need, then click "Confirm" button, and enter into installation process. The process may need some time, and the duration is related to your computer configuration, please wait patiently.

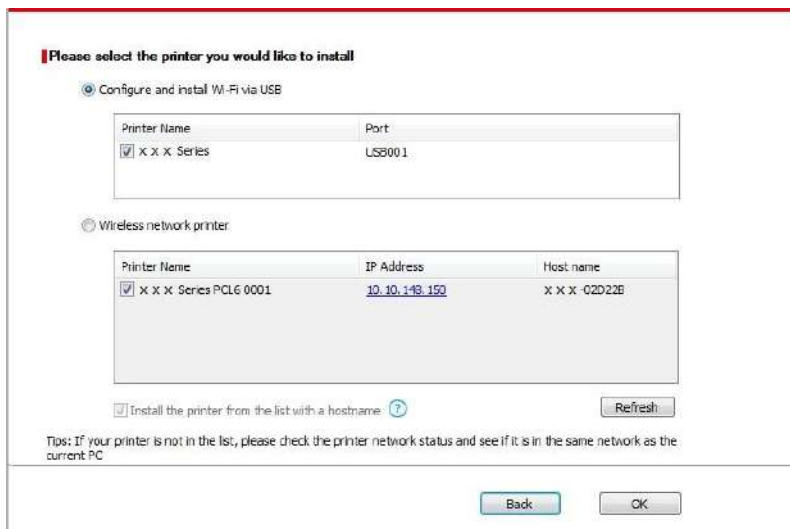
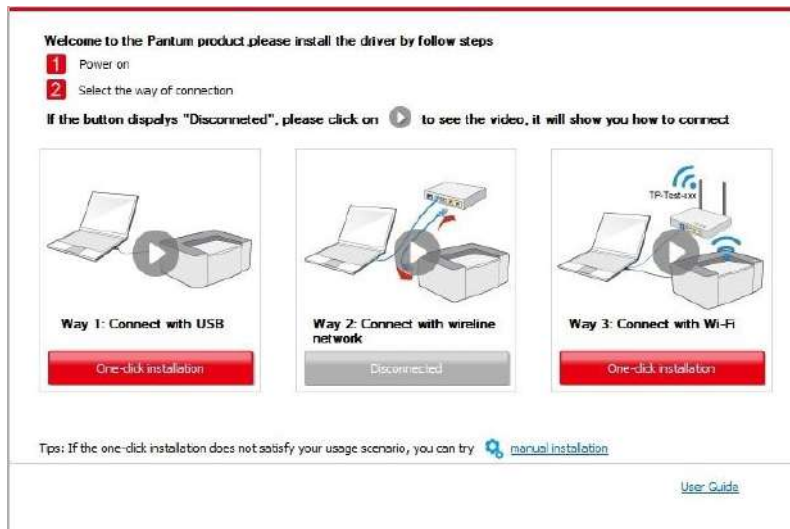

1. Please click on "Printing wireless network information page" to get the network name and encryption method. Please skip this step if you already know the network name and encryption method.

[Printing wireless network information page](#)

2. Please enter wireless network user name and password.

Network Name(SSID):

Encryption method:

Password:

Show password:



Note: • When the printer IP address changes under printer driver installed with host ID , you can also directly print without re-installing the driver. If you need to install the printer driver with the host ID, please check the option "Install the printer in the list with host ID".

6. After the installation, click "Print & Test Page" button. If your printer prints the test page successfully, it means that you have installed the driver correctly.

3.1.1.3.1.2. Connect computer to printer via Wi-Fi direct and install the driver

Connect the computer to printer via a direct Wi-Fi connection. It is applicable to wireless network without infrastructure mode, but it still needs scenario of temporary use of printer via wireless network. You can directly connect the computer that has wireless function to the printer to realize printing function.

1. Turn the power of printer and computer on.
2. Connect computer to the Wi-Fi Direct network of the printer (please refer to [Chapter 5.2.2](#) for setup method).
3. Place the attached installation CD in the computer CD-ROM:
 - Windows XP system: automatically run the installation procedure.
 - Windows 7/Vista/Server 2008 system: Pop up "Autoplay" interface, click "Autorun.exe" to run the installation procedure.
 - Windows 8 system: When the "DVD RW driver" window pops up from the right top corner of Computer desktop, click anywhere in the pop-up window, then click "Autorun.exe" to run the installation program.
 - Windows 10 system: When the "DVD RW driver" window pops up from the lower right corner of Computer desktop, click anywhere in the pop-up window, then click "Autorun.exe" to run the installation program.



Note: • Some computers may be unable to auto play the CD because of system configuration. Please double click "Computer" icon, find "DVD RW driver", then double click "DVD RW driver" to run the installation procedure.

4. Read and agree to the terms contained in the End User License Agreement and the Privacy Policy, click the "Next" button in the lower right corner of the interface to enter the driver installation interface.

5. Click on the "One-click installation" button in Method III, and enter into installation process. The process may need some time, and the duration is related to your computer configuration, please wait patiently.



6. After the installation, click "Print & Test Page" button. If your printer prints the test page successfully, it means that you have installed the driver correctly.

3.1.1.3.2. The printer is already connected to wireless network

1. The printer is already connected to wireless network, you can print the "Network configuration page" to check. (See [Chapter 11.6](#) to for how to print).
2. Connect the computer to printer network.
3. Place the attached installation CD in the computer CD-ROM:
 - Windows XP system: automatically run the installation procedure.
 - Windows 7/Vista/Server 2008 system: Pop up "Autoplay" interface, click "Autorun.exe" to run the installation procedure.
 - Windows 8 system: When the "DVD RW driver" window pops up from the right top corner of Computer desktop, click anywhere in the pop-up window, then click "Autorun.exe" to run the installation program.
 - Windows 10 system: When the "DVD RW driver" window pops up from the lower right corner of Computer desktop, click anywhere in the pop-up window, then click "Autorun.exe" to run the installation program.



Note: • Some computers may be unable to auto play the CD because of system configuration. Please double click "Computer" icon, find "DVD RW driver", then double click "DVD RW driver" to run the installation procedure.

4. Read and agree to the terms contained in the End User License Agreement and the Privacy Policy, click the "Next" button in the lower right corner of the interface to enter the driver installation interface.
5. Click the "One-click installation" button in Method III to install driver software.



Note: • You can put your mouse cursor in the "One-click installation" button to check the popup information in order to confirm if the current printer is the one you need to install through IP address before you click the button.

- You can check the printer IP address through "Network configuration page" (Please see [Chapter 11.6](#) for how to print)

- Click on the "One-click installation" button to enter installation process if your software has searched only one printer. The process may need some time, and the duration is related to your computer configuration. Please wait patiently.

Welcome to the Pantum product, please install the driver by follow steps

- 1 Power on
- 2 Select the way of connection

If the button displays "Disconnected", please click on  to see the video, it will show you how to connect.

| | | |
|---|--|---|
|  Way 1: Connect with USB Disconnected |  Way 2: Connect with wireline network Disconnected |  Way 3: Connect with Wi-Fi One-click installation |
|---|--|---|

Tips: If the one-click installation does not satisfy your usage scenario, you can try [manual installation](#)

[User Guide](#)

Tips:

Installing the driver software will take some time. Please be patient.
Please do not turn off the computer or run other operations that may affect normal installation.



- If the software has searched several printers, the printer list interface will pop up. Please select the printer you need according to your printer wired network IP address or host ID .

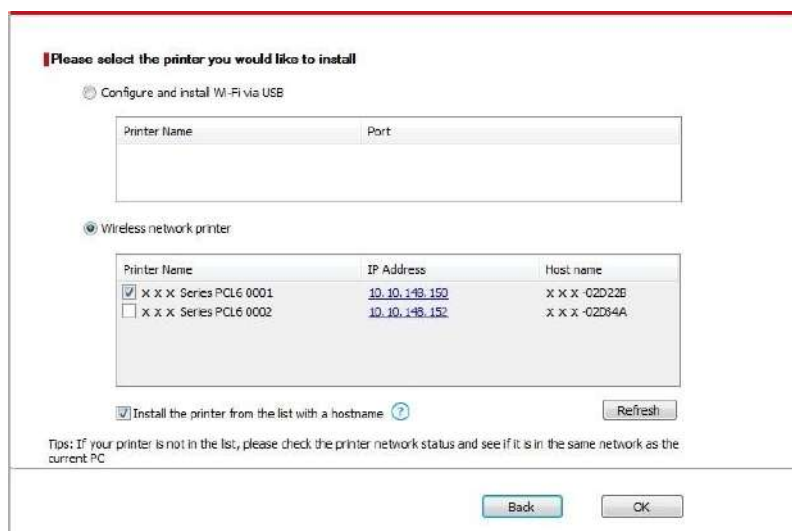
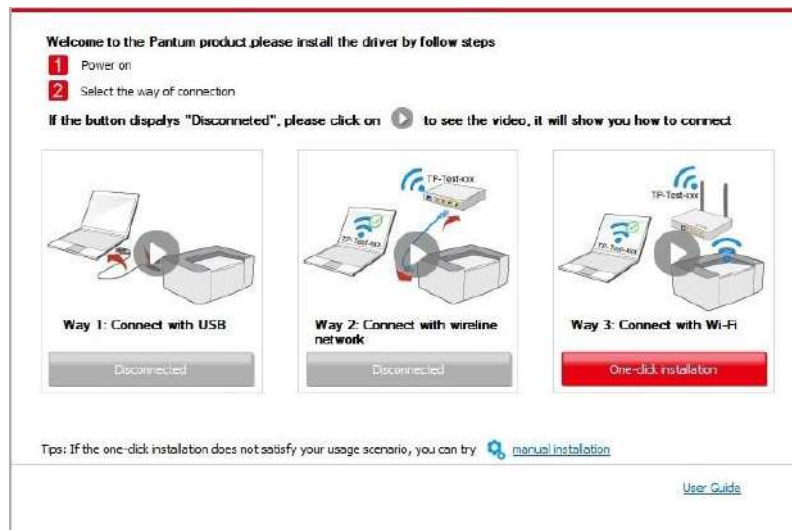

-
- Note:** • If the printer you need is not shown in the list, please click "Refresh" button to search again. If it is not found, please check if the printer and computer are in the same network. (Please see [Chapter 5.3](#) for how to check).
- When the printer IP address changes under printer driver installed with host ID , you can also directly print without re-installing the driver. If you need to install the printer driver with the host ID, please check the option "Install the printer in the list with host ID".
-

6. After the installation, click "Print & Test Page" button. If your printer prints the test page successfully, it means that you have installed the driver correctly.

3.1.2. Manual installation

- Before installing the drive, you need to learn about printer model by printing printer information page out and check the product name (please refer to [Chapter 11.6](#) for printing methods).

3.1.2.1. Installation via USB connection

1. Connect the printer to computer via USB cable, power the printer and computer on.
2. Place the attached installation CD in the computer CD-ROM:
 - Windows XP system: automatically run the installation procedure.
 - Windows 7/Vista/Server 2008 system: Pop up "Autoplay" interface, click "Autorun.exe" to run the installation procedure.
 - Windows 8 system: When the "DVD RW driver" window pops up from the right top corner of Computer desktop, click anywhere in the pop-up window, then click "Autorun.exe" to run the installation program.
 - Windows 10 system: When the "DVD RW driver" window pops up from the lower right corner of Computer desktop, click anywhere in the pop-up window, then click "Autorun.exe" to run the installation program.



Note: • Some computers may be unable to auto play the CD because of system configuration. Please double click "Computer" icon, find "DVD RW driver", then double click "DVD RW driver" to run the installation procedure.

3. Read and agree to the terms contained in the End User License Agreement and the Privacy Policy, click the "Next" button in the lower right corner of the interface to enter the driver installation interface.
4. Click on the "Manual installation" at the bottom of driver installation interface, and enter into manual installation interface.
5. Please select installation language and printer model.

6. Select "Connect via USB" and click on "Install".

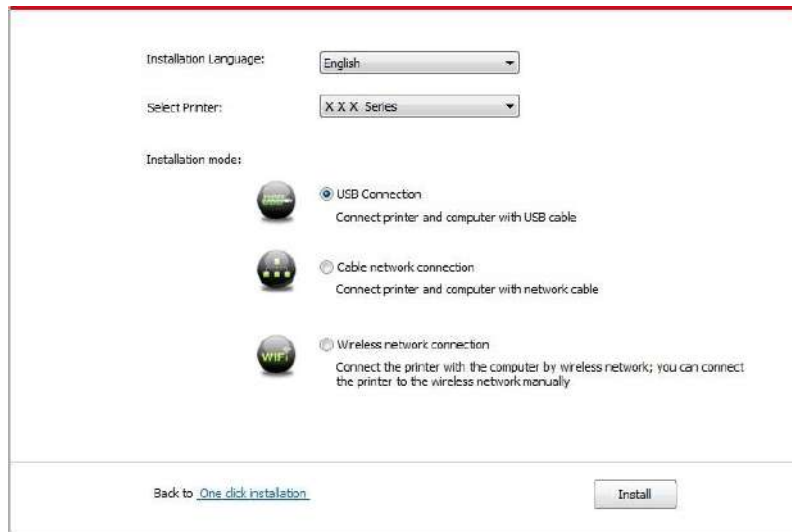

7. The software installs the driver automatically and the installation process may need some time. The duration is related to your computer configuration, please wait patiently.

8. After the installation, click "Print & Test Page" button. If your printer prints the test page successfully, it means that you have installed the driver correctly.

3.1.2.2. Installation via wired network connection

1. Turn the power of printer and computer on.
2. Connect the computer to wired network.
3. Connect network cable to the network interface of printer, to make sure the printer is connected to computer network (please refer to [Chapter 4](#) for network setup).
4. Place the attached installation CD in the computer CD-ROM:
 - Windows XP system: automatically run the installation procedure.
 - Windows 7/Vista/Server 2008 system: Pop up "Autoplay" interface, click "Autorun.exe" to run the installation procedure.
 - Windows 8 system: When the "DVD RW driver" window pops up from the right top corner of Computer desktop, click anywhere in the pop-up window, then click "Autorun.exe" to run the installation program.
 - Windows 10 system: When the "DVD RW driver" window pops up from the lower right corner of Computer desktop, click anywhere in the pop-up window, then click "Autorun.exe" to run the installation program.



Note: • Some computers may be unable to auto play the CD because of system configuration. Please double click "Computer" icon, find "DVD RW driver", then double click "DVD RW driver" to run the installation procedure.

5. Read and agree to the terms contained in the End User License Agreement and the Privacy Policy, click the "Next" button in the lower right corner of the interface to enter the driver installation interface.
6. Click on the "Manual installation" at the bottom of driver installation interface, and enter into manual installation interface.
7. Please select installation language and printer model.
8. Select "Wireline network connection" and click on "Install".

The screenshot shows a software installation window with the following elements:

- Installation Language:** A dropdown menu set to "English".
- Select Printer:** A dropdown menu set to "X X X Series".
- Installation mode:** Three radio button options:
 - USB Connection**: Connect printer and computer with USB cable.
 - Cable network connection**: Connect printer and computer with network cable.
 - Wireless network connection**: Connect the printer with the computer by wireless network; you can connect the printer to the wireless network manually.
- Navigation:** A link "Back to [One click installation](#)" and an "Install" button.

9. The installation software will search the printer automatically and the searching process may need some time.
10. After finishing searching, select the printer that needs to be connected and click "Next".

The screenshot shows a software installation window titled "Detected Printer" with the following elements:

- Detected Printer:** A table listing detected printers.

| Printer Name | IP Address | Host name |
|--|---------------|---------------|
| <input checked="" type="checkbox"/> X X X Series PCL6 0001 | 10.10.148.140 | X X X -779888 |
- Installation Options:**
 - Install the printer from the list with a hostname. Includes a "Refresh" button.
 - Add the IP address or hostname manually. Includes an empty text input field.
- Navigation:** "Previous", "Next", and "Exit" buttons.



Note: • If the printer you need to connect is not in the list of printers searched, please click “Refresh” to search again.

- When the printer IP address changes under printer driver installed with host ID , you can also directly print without re-installing the driver. If you need to install the printer driver with the host ID, please check the option "Install the printer in the list with host ID".
 - If IP address or host name is added manually, you need to know the IP address of the printer connected or host name. If they are not made clear, please print the “NetConf Pg” and view “IP Address” and “Host name” (Please refer to [Chapter 11.6](#)).
-

11. The software installs the driver automatically and the installation process may need some time. The duration is related to your computer configuration, please wait patiently.

12. After the installation, click "Print & Test Page" button. If your printer prints the test page successfully, it means that you have installed the driver correctly.

3.1.2.3. Installation by wireless network connection mode

Wireless network connection type is divided into basic structure mode and Wi-Fi Direct mode (please refer to [Chapter 5](#) for details).

3.1.2.3.1. Installation in basic structure mode

1. Connect computer to access point (wireless router).
2. Connect the printer to computer via USB cable, then power the printer on.
3. Place the attached installation CD in the computer CD-ROM:
 - Windows XP system: automatically run the installation procedure.
 - Windows 7/Vista/Server 2008 system: Pop up "Autoplay" interface, click “Autorun.exe” to run the installation procedure.
 - Windows 8 system: When the “DVD RW driver” window pops up from the right top corner of Computer desktop, click anywhere in the pop-up window, then click “Autorun.exe” to run the installation program.
 - Windows 10 system: When the “DVD RW driver” window pops up from the lower right corner of Computer desktop, click anywhere in the pop-up window, then click “Autorun.exe” to run the installation program.



Note: • Some computers may be unable to auto play the CD because of system configuration. Please double click "Computer" icon, find "DVD RW driver", then double click "DVD RW driver" to run the installation procedure.

4. Read and agree to the terms contained in the End User License Agreement and the Privacy Policy, click the "Next" button in the lower right corner of the interface to enter the driver installation interface.
5. Click on the "Manual installation" at the bottom of driver installation interface, and enter into manual installation interface.
6. Please select installation language and printer model.
7. Select "Wireless network connection" and click on "Install".



8. Select "Yes, I want to configure the printer's wireless network" on the wireless setup window popped out, and operate according to the prompts to set up the printer to wireless network (please refer to [Chapter 5.1.1](#) for setup method).

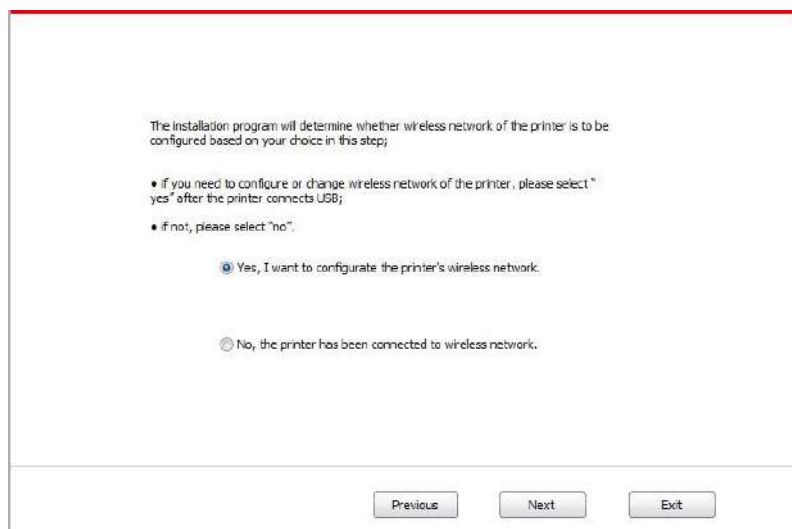

9. The installation software will search the printer automatically after wireless network is configured successfully. The search process may need some time.

10. Select the printer needs to be connected and click “Next”.

| Printer Name | IP Address | Host name |
|--|---------------|--------------|
| <input checked="" type="checkbox"/> X X X Series PCL6 0001 | 10.10.148.140 | X X X-779888 |

Install the printer from the list with a hostname

Add the IP address or hostname manually



Note: • If the printer you need to connect is not in the list of printers searched, please click “Refresh” to search again.

- When the printer IP address changes under printer driver installed with host ID , you can also directly print without re-installing the driver. If you need to install the printer driver with the host ID, please check the option "Install the printer in the list with host ID".
- If IP address or host name is added manually, you need to know the IP address of the printer connected or host name. If they are not made clear, please print the “NetConf Pg” and view “IP Address” and “Host name” (Please refer to [Chapter 11.6](#)).

11. The software installs the driver automatically and the installation process may need some time. The duration is related to your computer configuration, please wait patiently.

12. After the installation, click "Print & Test Page" button. If your printer prints the test page successfully, it means that you have installed the driver correctly.

3.1.2.3.2. Installation in Wi-Fi Direct mode

1. Turn the power of printer and computer on.

2. Connect computer to the Wi-Fi Direct network of the printer (please refer to [Chapter 5.2.2](#) for setup method).

3. Place the attached installation CD in the computer CD-ROM:

- Windows XP system: automatically run the installation procedure.
- Windows 7/Vista/Server 2008 system: Pop up "Autoplay" interface, click “Autorun.exe” to run the installation procedure.

- Windows 8 system: When the “DVD RW driver” window pops up from the right top corner of Computer desktop, click anywhere in the pop-up window, then click “Autorun.exe” to run the installation program.
- Windows 10 system: When the “DVD RW driver” window pops up from the lower right corner of Computer desktop, click anywhere in the pop-up window, then click “Autorun.exe” to run the installation program.



Note: • Some computers may be unable to auto play the CD because of system configuration. Please double click "Computer" icon, find "DVD RW driver", then double click "DVD RW driver" to run the installation procedure.

4. Read and agree to the terms contained in the End User License Agreement and the Privacy Policy, click the “Next” button in the lower right corner of the interface to enter the driver installation interface.
5. Click on the "Manual installation" at the bottom of driver installation interface, and enter into manual installation interface.
6. Please select installation language and printer model.
7. Select "Wireless network connection" and click on "Install".

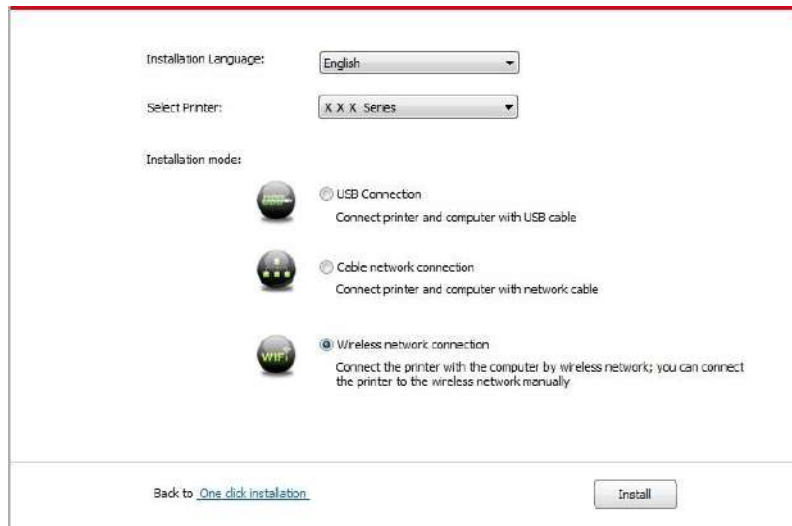

8. Select “No, the printer has been connected to wireless network” on the wireless setup window popping out, and then click “Next”.

The installation program will determine whether wireless network of the printer is to be configured based on your choice in this step;

- if you need to configure or change wireless network of the printer, please select "yes" after the printer connects USB;
- if not, please select "no".

Yes, I want to configure the printer's wireless network.

No, the printer has been connected to wireless network.

Previous Next Exit

9. The installation software will search the printer automatically and the searching process may need some time.

10. Select the printer needs to be connected and click “Next”.

Detected Printer

| Printer Name | IP Address | Host name |
|--|---------------|---------------|
| <input checked="" type="checkbox"/> X X X Series PCL6 0001 | 10.10.148.143 | X X X -779888 |

Install the printer from the list with a hostname

Add the IP address or hostname manually

Previous Next Exit



Note: • If the printer you need to connect is not in the list of printers searched, please click “Refresh” to search again.

- When the printer IP address changes under printer driver installed with host ID , you can also directly print without re-installing the driver. If you need to install the printer driver with the host ID, please check the option "Install the printer in the list with host ID".
 - If IP address or host name is added manually, you need to know the IP address of the printer connected or host name. If they are not made clear, please print the “NetConf Pg” and view “IP Address” and “Host name” (Please refer to [Chapter 11.6](#)).
-

11. The software installs the driver automatically and the installation process may need some time. The duration is related to your computer configuration, please wait patiently.

12. After the installation, click "Print & Test Page" button. If your printer prints the test page successfully, it means that you have installed the driver correctly.

3.1.3. Method of driver unistallation

Windows 7 is taken as the example in the following operation. The information on your computer screen may differ because of multiple operating systems.

1. Click the Start menu of computer and then click All programs.
2. Click Pantum, and then Click Pantum XXX Series.
Pantum XXX Series where XXX represents product model.
3. Click uninstall to delete the driver according to instructions on uninstall window.
4. Restart computer after finishing unloading.

3.2. macOS system driver installation

- Driver installation under macOS system is divided into 2 steps, driver installation and adding a printer. If you are going to print in AirPrint mode, there is no need to install a driver and you just need to add a printer directly.
- When you are installing a driver with wired or wireless network, you may need to know the Bonjour name of printer. Please print the “Network setup page” to view it. (Please refer to [Chapter 11.6](#)).

3.2.1. Driver installation

macOS 10.14 is taken as the example in the following operation. The information on your computer screen may differ because of multiple operating systems.

1. Turn the power of printer and computer on.

2. Insert the CD accompanying with printer in the CD driver of your computer, and double click Pantum XXX Series installation package. (**XXX** in Pantum XXX Series represents product model.)



3. Click “Continue”.

4. Read licensing agreement and then click “Continue”.

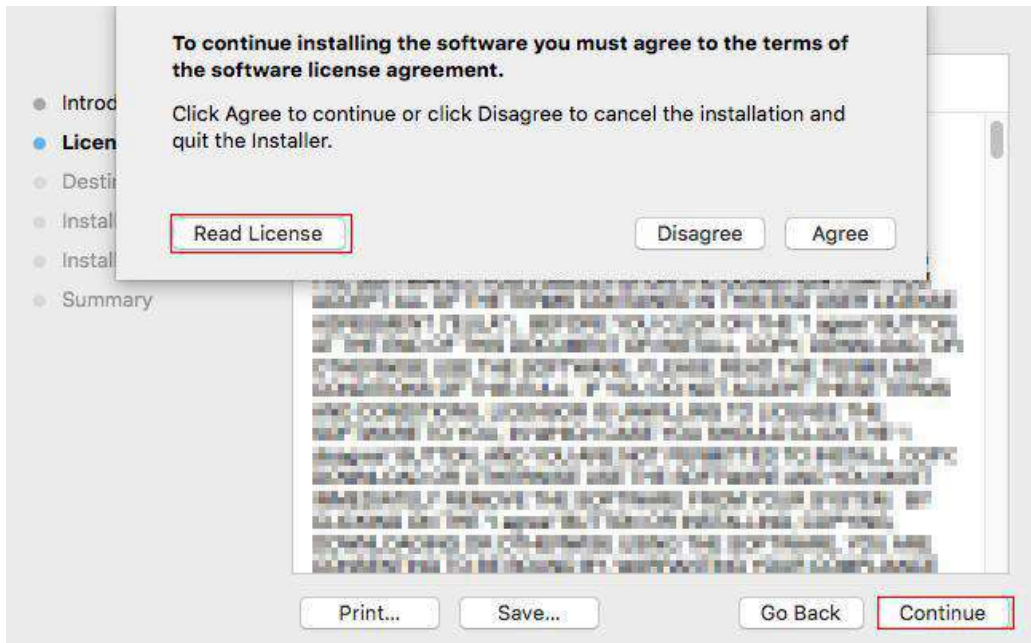

5. Click “Agree” on the prompt window popping out to accept the licensing agreement.

6. Read the Privacy Policy and press "Continue".

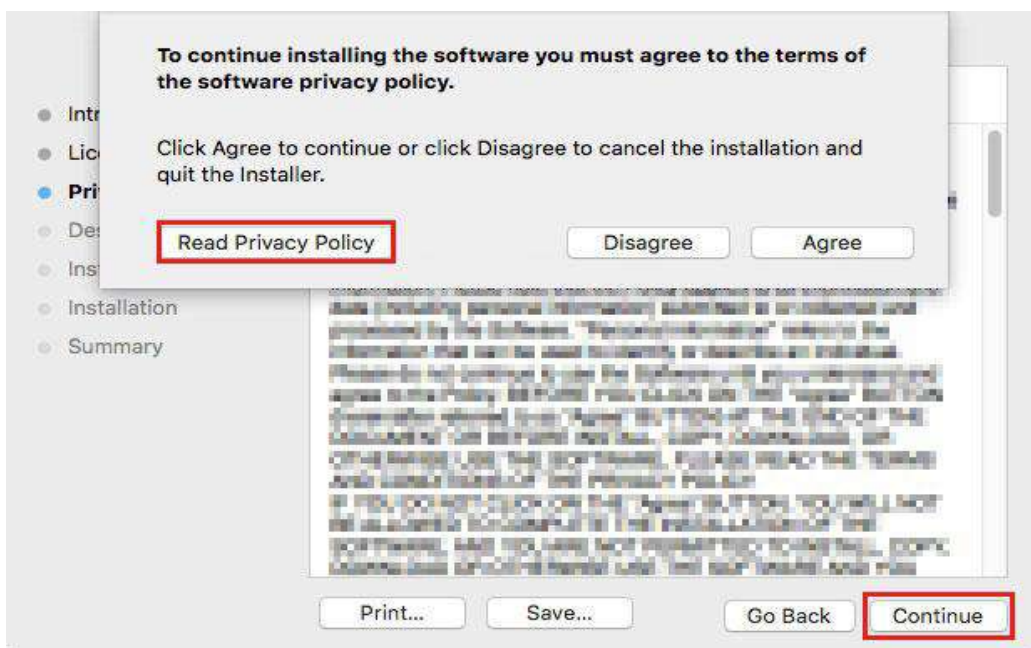

7. In the popped-up prompt window, press "Agree" to accept the Privacy Policy.

8. Click "Install".

9. Input computer password and click "Install Software".

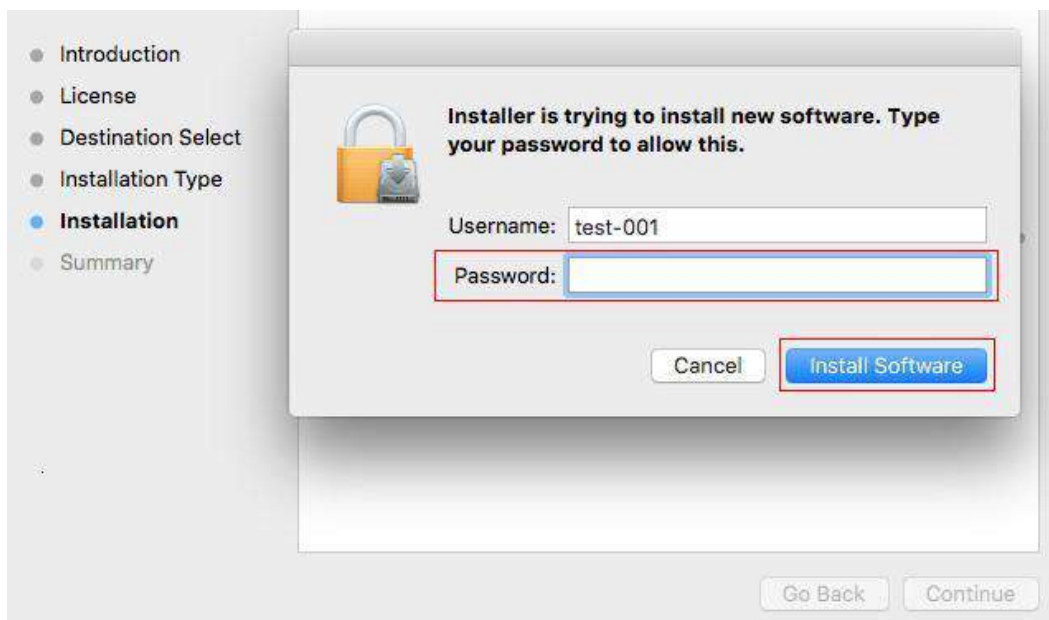

10. Click "Continue Installation" on the prompt window popping out.
11. The system will finish driver installation automatically.
 - If using a USB cable to connect a computer with a Wi-Fi model printer, a wireless network configuration prompt window will pop up during driver installation, as shown in following picture.

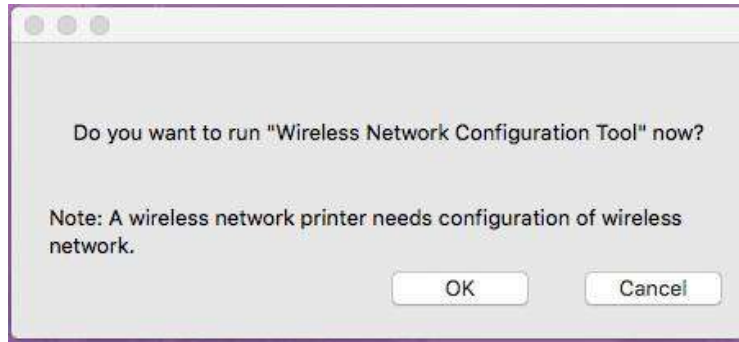

-
-  **Note:** • click "Yes", you can configure printer's wireless network via wireless network configuration tool (refer to [Chapter 5.1.1](#) for how to make configuration).When configuration is completed, unplug USB cable, and then on the pop-up "Add Printer" interface, you may add the network-connected printer(refer to [Chapter 3.3](#) for how to add printer).
- Click "No", you can add a USB-connected printer on the pop-up "Add Printer" interface (refer to [Chapter 3.3](#) for how to add printer).
-

If using a USB cable to connect a computer with a non-Wi-Fi model printer, a "Add Printer" interface will pop up during the driver installation and you can add a printer here (refer to [Chapter 3.3](#) for how to add printer).

3.3. Add printer to macOS system

3.3.1. Add up the printer via USB

1. Connect the printer to computer with USB cable and then turn power on.
2. Enter the “System Preferences” – “Printers & Scanners” of computer.
3. Click  button to select “Add Printer or Scanner”.
4. Select printer and then select the corresponding printer mode from the “Use” menu popping out.
5. Click “Add”.

3.3.2. Add up the printer via wireline connection

1. Turn the power of printer and computer on.
2. Connect the computer to wired network.
3. Connect the network cable to the network interface of printer, and make sure the printer is connected to the computer network (Please refer to [Chapter 4](#) for network setup).
4. Enter the “System Preferences” – “Printers & Scanners” of computer.
5. Click  button to select “Add Printer or Scanner”.
6. Select printer and then select the corresponding printer mode from the “Use” menu popping out.
7. Click “Add”.

3.3.3. Add up the printer via wireless connection

1. Turn the power of printer and computer on.
2. Make sure the wireless network connection between computer and printer is set up.



Note: • In case of basic structure mode, connect wireless network printer to the access point (wireless router). Please refer to [Chapter 5.1](#) for connection method.

- In case of Wi-Fi Direct mode, connect wireless client to wireless network printer directly. Please refer to [Chapter 5.2](#) for connection methods.

3. Enter the “System Preferences” – “Printers & Scanners” of computer.
4. Click  button to select “Add Printer or Scanner”.
5. Select printer and then select the corresponding printer mode from the “Use” menu popping out.
6. Click “Add”.

3.3.4. Add AirPrint printer

1. Turn the power of printer and computer on.
2. Make sure the connection between printer and computer is set up (USB connection or network connection).
3. Enter the “System Preferences” – “Printers & Scanners” of computer.
4. Click  button to select “Add Printer or Scanner”.
5. Select printer and select “Secure AirPrint” (data encryption) or “AirPrint” (no encryption) in the “Use” option box.
6. Click “Add”.



Note: • When the printer is connected to computer with USB cable, the system will recognize and add AirPrint automatically.

- If AirPrint printer of network connection is added, then the connecting USB cable should be disconnected first before adding the printer.
 - AirPrint printer is named after the ending of "AirPrint".
-

4. Wired network setup (applicable to wired network models)

In case printers support wired network printing, they can be connected to network to control printer to print in wired network mode.

4.1. Set IP Address

The IP address of the printer may be automatically obtained through DHCP function or set manually.

4.1.1. Automatic Setting

DHCP automatic setting function is enabled by default on the printer.

1. Connect the printer to the network through a network cable and complete the startup preparation work.

2. The printer will receive the IP address assigned by server automatically. It may take server minutes to receive IP address under the influence of network environment.

You can check the IP address of printer by printing "Network setup page" out (please refer to [Chapter 11.6](#) for printing method) or check network information by viewing the control panel of printer (please refer to [Chapter 11.4](#) for viewing methods). If the IP address is not listed, please check network environment and then try again after waiting for several minutes.



Note: • If DHCP server fails to assign IP address automatically, the printer will get the link-local address assigned by printer automatically: 169.254.xxx.xxx.

4.1.2. Manual Setting

To set up IP address for printer through the control panel of printer manually, please refer to [Chapter 11.3](#) for details.

To set up IP address for printer through the embedded Web server manually, please refer to [Chapter 6.2.1](#) for details.

5. Wireless network setup (applicable to Wi-Fi models)

Wireless network connection type is divided into basic structure mode and Wi-Fi Direct mode. If you have problems with wireless network setup, please refer to [Chapter 5.3](#) Wireless Network Setup FAQs.

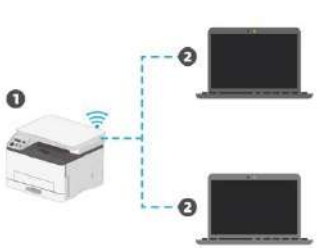
| | |
|--|--|
|  | <p>Basic structure mode: connecting to a wireless device via router</p> <ol style="list-style-type: none">1. Access point (wireless router)2. Wireless network printer3. Computer connecting to access point via wireless network4. Computer connecting to access point via network cable |
|  | <p>Wi-Fi Direct mode: wireless client is connecting to a printer with Wi-Fi function</p> <ol style="list-style-type: none">1. Wireless network printer2. Wireless client is directly connecting to a wireless network printer |

5.1. Basic structure mode

You can connect a computer to your printer via access point (wireless router) as the medium. Access point (wireless router) connection is divided into wireless network setup and Wi-Fi Protected Setup (WPS).

Important: Before wireless network installation, you must learn about the service set identifier (SSID) and password of your access point in order to use them during wireless network setup. If they cannot be determined, please consult your network administrator or a

5.1.1. Wireless network setup tools

If your computer has been installed with a driver and had been connected to wireless network, but the wireless network was changed, you can set it again with wireless network setup tools.

5.1.1.1. Preliminary preparations

1. Access point (wireless router)
2. A computer that has been connected to network.

3. A printer that has wireless network function.

5.1.1.2. Setup methods of wireless network setup tools

1. Take the wireless network setup tool in computer.

1) Windows system: Click the “Start menu” - “All programs” - “Pantum” — Product name - “Wireless network setup tool” .

2) macOS system: click "Go" - "Applications" - "Pantum" - "Utilities" - "Wireless Network Configuration Tool" on the computer Finder menu bar.

2. Use USB cable to connect and configure.

Select "Yes, I have an USB cable that can be used for installation" in the following interface. Click "Next".

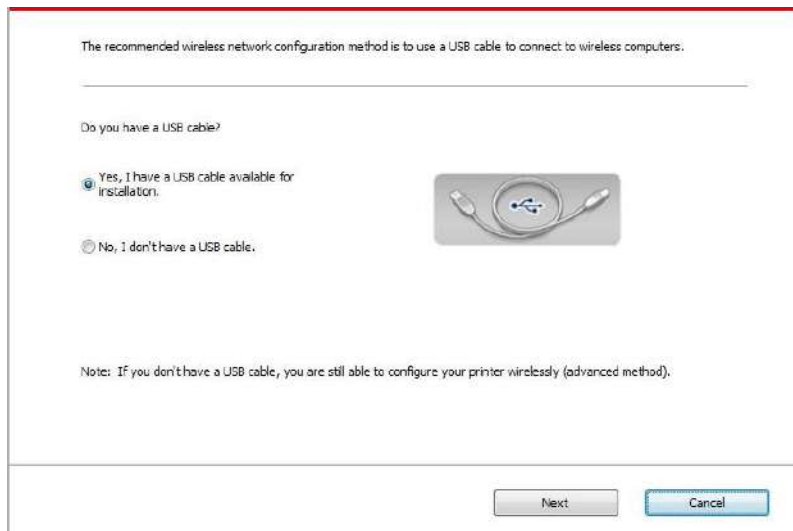

2.1 The computer has been connected to wireless network.

1) The currently wireless network currently connected to computer is selected as wireless network configuration tool by default. Complete configuration according to interface prompt.

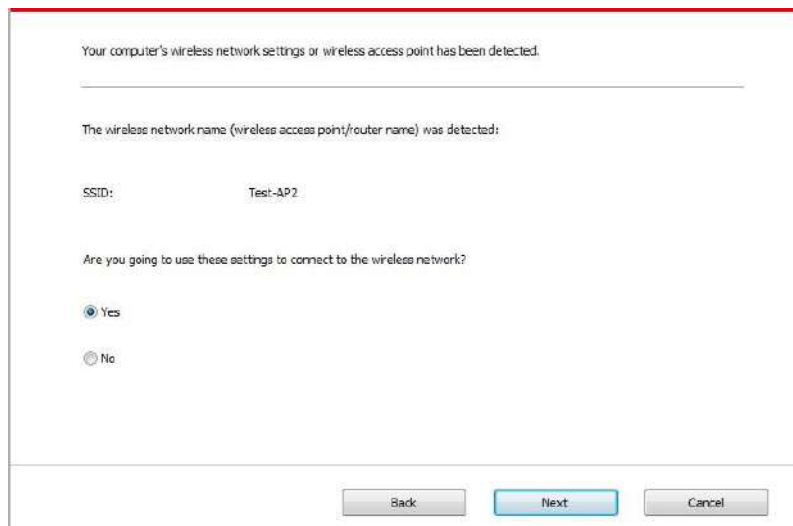

 **Note:** • The SSID you selected should be consistent with the SSID of access point (wireless router) connected to your computer.

2) Please tick “No” to configure other wireless network needed to connect to. Complete configuration according to interface prompt.

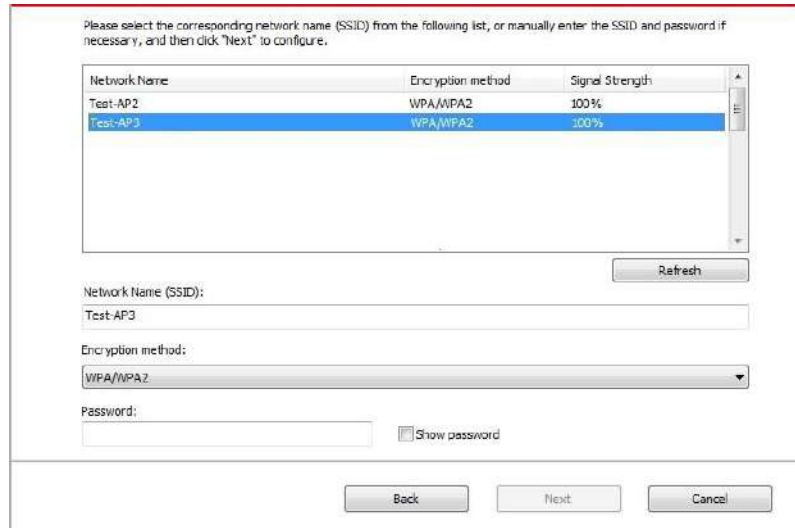

Please select the corresponding network name (SSID) from the following list, or manually enter the SSID and password if necessary, and then click "Next" to configure.

| Network Name | Encryption method | Signal Strength |
|--------------|-------------------|-----------------|
| Test-AP2 | WPA/WPA2 | 100% |
| Test-AP3 | WPA/WPA2 | 100% |

Network Name (SSID):
Test-AP3

Encryption method:
WPA/WPA2

Password:
 Show password

Back Next Cancel

 **Note:** • At present, the printer supports 3 types of safe modes: none, WEP and WPA/WPA2.

1) None: There is no encryption method used.

2) WEP: Send and receive data via security key by using WEP (Wired Equivalent Privacy). WEP key is applicable to 64-digit and 128-digit encrypted network and can contain numbers and letters at the same time.

3) WPA/WPA2: it is the pre-shared key (PSK) of Wi-Fi protected access which connects wireless device and access point via TKIP or AES encryption (WPS-Personal). The working length of WPA/WPA2 is within the PSK of 8-63 characters.

- The display password is not ticked by default; if it is ticked, all passwords input can be seen in clear text.

2.2 The computer is not connected to wireless network.

Input the SSID (case sensitive) and password of access point (wireless router) in the interface below. Complete configuration according to interface prompt.

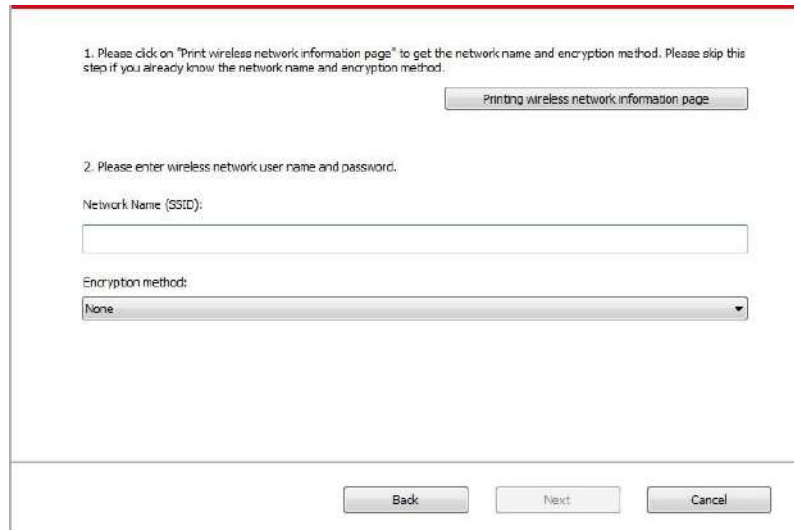

The screenshot shows a configuration window with the following elements:

- Step 1: "Please click on 'Print wireless network information page' to get the network name and encryption method. Please skip this step if you already know the network name and encryption method." A button labeled "Printing wireless network information page" is located to the right.
- Step 2: "Please enter wireless network user name and password." Below this are two input fields: "Network Name (SSID):" and "Encryption method:". The "Encryption method:" dropdown menu is currently set to "None".
- At the bottom, there are three buttons: "Back", "Next", and "Cancel".



Note: • If you do not know the SSID of access point (wireless router), please click “Print Wireless Network Information Page” to view the SSID of the needed access point (wireless router).

- If the printer cannot be used normally after wireless network setup is finished, please install the drive again.

3. Use WPS connection .

Select “No, I don't have a USB cable” in the interface below and then click “Next”.

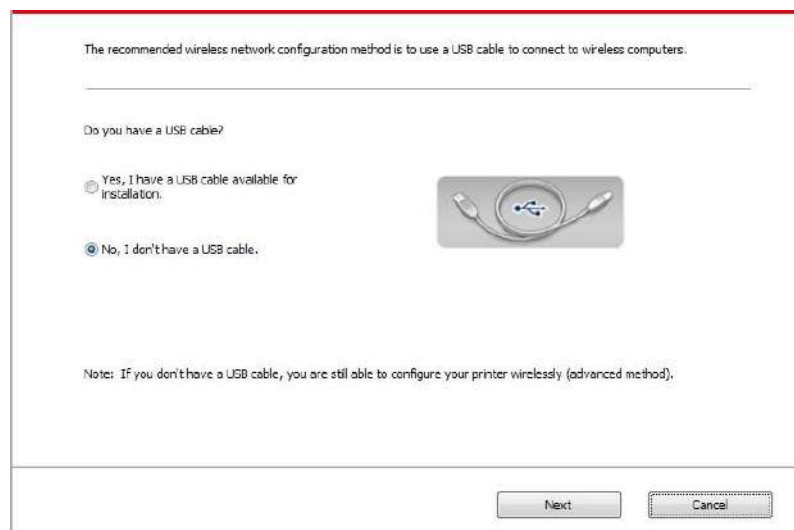

The screenshot shows a configuration window with the following elements:

- Text: "The recommended wireless network configuration method is to use a USB cable to connect to wireless computers." Below this is a horizontal line.
- Text: "Do you have a USB cable?"
- Two radio button options:
 - Yes, I have a USB cable available for installation.
 - No, I don't have a USB cable.
- An image of a USB cable is shown to the right of the options.
- Text: "Note: If you don't have a USB cable, you are still able to configure your printer wirelessly (advanced method)."
- At the bottom, there are two buttons: "Next" and "Cancel".

1) Use WPS method to perform steps below to start wireless network on printer. (Please refer to [Chapter 5.1.2](#) for detailed WPS configuration)

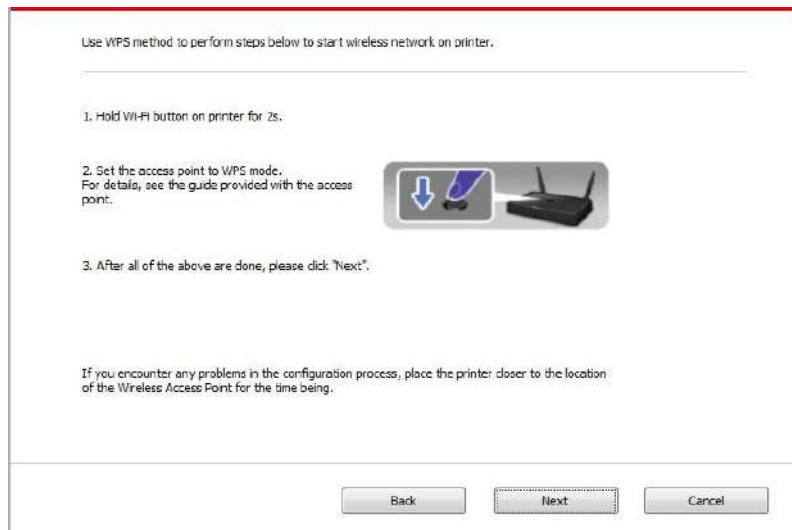

2) Judge if the printer is successfully connected according to the status of Wi-Fi indicator on printer. If configuration failed, please click "Previous" to configure again; if configuration succeeded, please click "Done" to complete configuration.

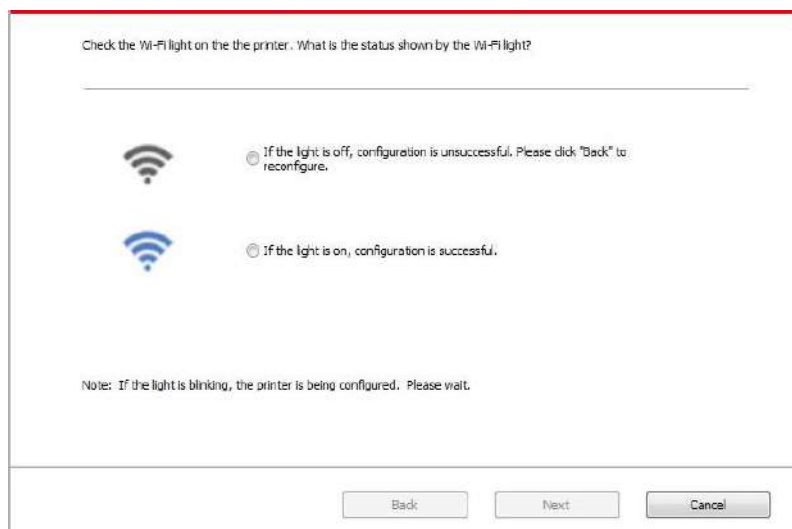

Note: • If the printer cannot be used normally after wireless network setup is finished, please install the drive again.

5.1.2. Wi-Fi Protected Setup (WPS) setup

If the access point (wireless router) supports Wi-Fi Protected Setup (WPS), the Wi-Fi key on the control panel of printer and WPS key on access point (wireless router) can be pressed in order to connect the printer to wireless network.

5.1.2.1. Preliminary preparations

1. The access point (wireless router) supports Wi-Fi Protected Setup (WPS).
2. A printer that has wireless network function.

5.1.2.2. Wi-Fi Protected Setup (WPS) method

1. Turn on the power of printer and access point (wireless router).
2. Make sure the printer is in ready state.



Note:• If the printer is in sleep mode, it can be woken up by pressing any key on the control panel of printer.

3. Press "Wi-Fi" button on the printer panel for over 2s until the Wi-Fi indicator flashes in blue and then release the button.
4. Press the WPS key on access point (wireless router) within 2min and then release it.
5. When the access point (wireless router) and printer start to connect, the blue Wi-Fi indicator of printer starts to blink. The blue Wi-Fi indicator of printer will be normally on after successful connection.

If the connection is not established after more than 2min, the printer will return to its ready state, the Wi-Fi indicator will be off and Wi-Fi Protected Setup (WPS) connection will fail. If it is needed to connect again, please repeat steps 3-4 above.



Note:• Please refer to [Chapter 5.1.3](#) for how to cancel and disconnect Wi-Fi connection.

- After successful Wi-Fi Protected Setup (WPS) connection, please install a driver if you want to print via wireless network.
-

5.1.3. How to disable the Wi-Fi network connected

Connect the wireless network in infrastructure mode by the steps above. If connected, the Wi-Fi light on the control panel is normally on. Press and hold this button for more than 2s to disconnect from Wi-Fi network (Wi-Fi light will be off).

5.2. Wi-Fi Direct mode

You can connect wireless client (including the computer and mobile device with wireless network feature) to wireless network printer without using the access point (wireless router).

5.2.1. Preliminary preparations

1. Printer with the Wi-Fi Direct feature.
2. Wireless client (including computer and mobile device with wireless network feature).

5.2.2. Wi-Fi Direct connection

Before connecting to printer hotspot, turn on direct Wi-Fi connection of the printer by short pressing "Wi-Fi" button on the panel.



Note: • Short press "Wi-Fi" button on the printer panel to automatically print out "Mobile Device Wi-Fi Connection Wizard" page for Wi-Fi connection by mobile devices.

5.2.2.1. Connection method of wireless client that supports Wi-Fi Direct feature (direct invitation to connect)

You must use mobile devices that support Wi-Fi Direct function for Wi-Fi Direct connection. The operating steps may differ because of the mobile device you are using.

1. Turn on printer power.
2. Turn on the mobile device and select setup to enter Wi-Fi connection interface.

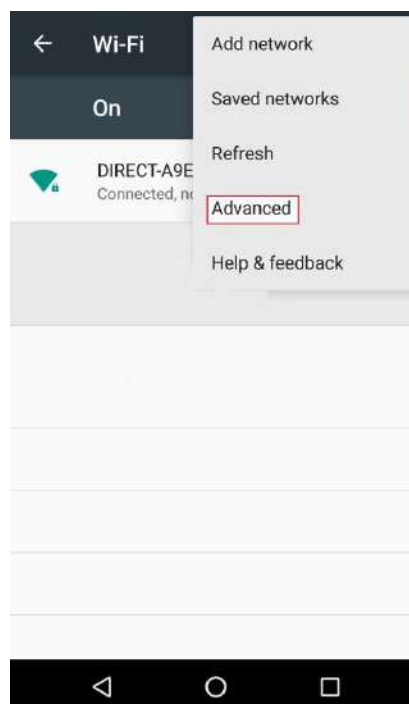

3. Select “Advanced” and then select “Wi-Fi Direct” in advanced WLAN interface.

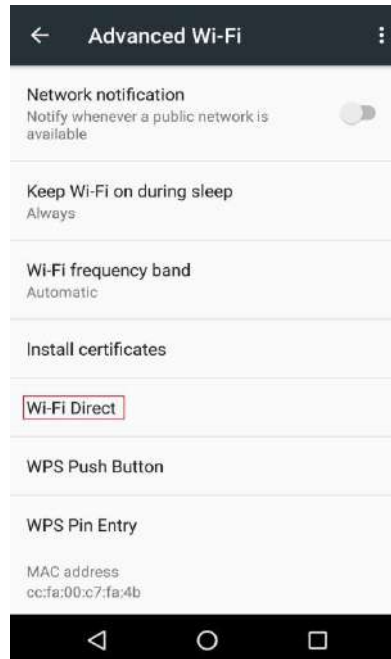

4. Select printer SSID on direct interface to launch a connection invitation.

5. Press “OK key” to confirm connection when the panel lead to prompts whether to connect to start Wi-Fi Direct connection.

 **Note:** • In case of auto connection mode, the mobile device will start to connect automatically after initiating connection invitation without panel confirmation.

5.2.2.2. Connection method of wireless client that does not support Wi-Fi Direct function (input password to connect)

1. Turn on printer power.
2. Press the “Menu key” – “Network Info” – “Wi-Fi dir. Info” on control panel of printer to view "SSID" and "Password".
3. Turn on the computer or mobile device with wireless network function; select the SSID of Wi-Fi Direct and input password to connect.

5.2.3. How to disable the Wi-Fi Direct

1. Turn on printer power.
2. Press "Menu", "Network Set", "Wi-Fi Direct" and then "Off" on the printer's control panel to disable Wi-Fi Direct.

5.3. Wireless network setup FAQs

1. The printer is not found.
 - If the power of computer, access point (wireless router) or printer is turned on.

- If the computer is connected to printer with USB cable.
 - If the printer supports wireless network connection.
2. SSID cannot be found when network is connected
- Inspect if the power switch of access point (wireless router) is turned on.
 - The printer cannot find the SSID of the access point (wireless router) you need to connect, please check the SSID of access point and try to connect again.
 - Every time when the setup of access point (wireless router) is changed, you must set up the wireless network of printer again.
3. Connection failure
- Please inspect if the safe mode and password of access point (wireless router) and printer is correct.
 - Inspect the wireless receiving around printer. Signal receiving may be affected if the router is away from the printer or there is an obstacle between them.
 - Turn the power of access point (wireless router) and printer off and then restart them and set up.
4. The following aspects should be inspected if the printer has problems while they are used in network:
- Inspect if the firewall software blocks communication. If the computer and printer are connected in the same network but they cannot be searched, the communication might be blocked by firewall software. Please refer to the user guide of firewall software
 - Inspect if the IP address assignment of printer is correct. You can inspect IP address by printing the network setup information page of printer out.
 - Please refer to the following steps to check if printer and computer are in the same network:
 - 1) Select "Command prompt" as shown below.
 - a. Windows 8/10 system: Select "Search" button in the Start Menu and input "Command prompt" in search bar, then press the "Enter" button in the keyboard.
 - b. Windows 7/Vista/XP system: click "Start" menu-"All procedures"-"Attachment"-"Command prompt".
 - 2) Input ping and your printer IP address in popup window, and press "Enter" button.
For example: ping XXX.XXX.XXX.XXX("XXX.XXX.XXX.XXX" is printer IP address)
 - 3) If RTT is indicated in the window, that is to say your printer and computer are in the same network. If RTT is not indicated in the window, please refer to [Chapter 5](#) to re-configure the printer wireless network.



Note: • Please refer to the user guide or consult the manufacturer for information related to access point (wireless router).

6. Web server

You can manage printer setup via the embedded Web server.

6.1. Visit the embedded Web server

1. Turn on the power of printer and computer.
2. Connect the printer to network to ensure that the printer is connected to the network where the computer is connected to (please refer to [Chapter 4](#) or [Chapter 5](#) for network setup method).
3. Input the IP address of printer in the address bar of Web browser to visit the Web server imbedded in printer.

View the IP address of printer via control panel (please refer to [Chapter 11.4](#)) or print the “Network setup page” out to view the IP Address of printer (please refer to [Chapter 11.6](#)).



Note: • Windows users are suggested to use Microsoft Internet Explorer 8.0 (or higher version) or Firefox 1.0 (or higher version), Mac users are suggested to use Safari 4.0 (or higher version). No matter what kind of browser you are suing, please ensure that JavaScript and Cookies are always enabled. Please ensure compatibility with HTTP 1.0 and HTTP 1.1 when other network browsers are used.

- If the computer cannot visit the Web server embedded in printer, then your computer and printer may be connected to different networks. Please inspect your network environment or consult your network administrator.
-

4. Click “Log in” option, input user name and password (the default user name is admin and the initial password is 000000) and click “Log in”.



Note: • For safety reasons, you are suggested to change the default password, which can be finished in the “User Management” interface.

6.2. Use Web server to manage printer

You can use the embedded Web server to manage printer.

1. View the basic information including product name, printer state and ink cartridge of printer.
2. Set up the network protocol parameters supported by printer.
3. Set up the wireless network connection of printer, and turn on/off wireless network and Wi-Fi Direct function.
4. Set up mail server client and acquire printer state via E-mail notification.

5. It supports to configure e-mail address and FTP address to scan the file to be scanned directly to E-mail box or FTP server.



6.2.1. IP address setup

You need to connect your printer to network before IP address setup.

1. In case of wired network model, connect the printer to wired network by connecting to its network interface with network cable.
2. In case of wireless network model, the printer can be connected to wireless network via wireless network setup tools or Wi-Fi Protected Setup(WPS) (please refer to [Chapter 5.1.2](#)).

6.2.1.1. IPv4 setup

IPv4 address of the printer is divided into DHCP auto assignment and manual setting, and the DHCP auto assignment function is on by default. You can set up the IPv4 address of printer manually to set up fixed IPv4 address for the printer.

1. Turn on printer power to connect printer to network.
2. Log in the embedded Web server (please refer to [Chapter 6.1](#) for login method).
3. Click “Settings” – “Network settings” – “Protocol Settings” – “Wired IP Configuration”.
4. Set the IPv4 address assignment mode as “Manual”.
5. Input “IPv4 Address”, “Subnet Mask” and “Gateway Address”, and then click “Apply”.

6.2.1.2. IPv6 setup

1. Turn on printer power to connect printer to network.
2. Log in the embedded Web server (please refer to [Chapter 6.1](#) for login method).

3. Click “Settings” – “Network settings” – “Protocol Settings” – “IPv6”.
4. Tick “Enable IPv6 protocol” and “Enable DHCPv6” (ticked by default) and then click “Apply”. You can refresh the browser and view the “IPv6 Local Link Address” and “Stateful Address” in “Wired IP Configuration” interface.



Note: The printer supports using the following IPv6 addresses for network printing and management.

- IPv6 local-link address: local IPv6 address set up by oneself (addresses beginning with FE80).
 - Stateful address: IPv6 address set up by DHCPv6 server (if there is no DHCPv6 server in network, the “Stateful Address” cannot be assigned).
 - Stateless address: IPv6 address set up by network router automatically (please refer to [Chapter 11.6](#) and print “Network setup page” view IPv6 address).
-

6.2.2. Wireless setup

You can set up the wireless network, wireless IP setup, Wi-Fi Direct and WPS via wireless setup page. Before setup, please log in the embedded Web server (please refer to [Chapter 6.1](#) for login method).

6.2.2.1. Wireless network

1. Click “Settings” – “Network settings” – “Wireless setup” – “Wireless Network”.
 - 1) If you need to set up wireless network, please click the SSID of access point (wireless router) in search list, input secret key and click “Apply”.

6.2.2.2. Wireless IP setup

Only when the wireless network of printer is turned on, the Wireless IP Configuration can be displayed on Web server.

1. Click “Settings” – “Network settings” – “Wireless setup” – “Wireless IP Configuration”.
 - 1) DHCPv4 is ticked by default. If IP address needs to be set up manually, please cancel the DHCPv4 checkbox ticked and input the “IPv4 Address”, “Subnet Mask” and “Gateway Address” that you need to set up and then click “Apply”.

6.2.2.3. WPS setup

1. Click “Settings” – “Network settings” – “Wireless setup” – “WPS”.
 - 1) Select the “WPS Startup Method” you need, and then click “Apply” and operate according to page prompt.

6.2.2.4. Wi-Fi Direct setup

1. Click “Settings” – “Network settings” – “Wireless setup” – “Wi-Fi Direct”.



Note: • If Auto selected, the mobile terminal will realize automatic connection upon initiating the connection invitation without the need of confirmation on panel.

- If Manual selected, the mobile terminal cannot realize connection until initiating the connection invitation prior to confirmation on panel.

6.2.3. Machine setup

You can add mail address contacts, set up e-mail notification, set up sleep time and recover factory settings via machine setup page.

6.2.3.1. Set up e-mail notification

If you set up e-mail notification, an e-mail will be sent to the mail address specified by you when abnormality such as paper out occurs. You can receive emails only if you made correct email setup. Please consult your network administrator for detailed setup steps. You need to log in the embedded Web server before setting up email notification (please refer to [Chapter 6.1](#) for login method).

I. Set up SMTP client

1. Click “Settings” – “Network settings” – “Protocol Settings” – “SMTP”.
2. On SMTP page, input SMTP server address, set up the mailbox login name and password and then click “Apply”.

II. Add recipient address

1. Click “Settings” – “Machine settings” – “Address Book” .
2. Press “Email Address Book” - “New”, enter the contact name and email address, and then press “Apply”.

III. Set up email notification

1. Click “Settings” – “Machine settings” – “E-mail Notification”.
2. Press  and select the email address to be added in the pop-up contact list.

Or, check “Address X” (e.g. Address 1), and manually enter the email address to be added.

3. Check the desired email address and content of notification, and press “Apply”.

6.2.3.2. Configure the E-mail address book

If you want to scan a file to an e-mail address, you need to configure the e-mail address book first and then scan the file to the assigned e-mail address. The e-mail will not be received before proper setting on the e-mail box; for specific setting steps,

I. Set the E-mail address book

1. Log in the embedded Web server (please refer to [Chapter 6.1](#) for login method).
2. Click "Settings", "Machine Settings" and then "E-mail Address Book" to enter the setting interface of e-mail address book.
3. Click "Create" to pop out a window as below and edit the contact name and input the e-mail address, and then click "Apply".



Note:• If some groups have been created, you may click to check a corresponding group to add the newly created e-mail address into it.

The screenshot shows a dialog box titled "New" with a close button in the top right corner. It contains three input fields: "Contact Name" (empty), "Email Address" (empty), and "Group name" (containing the text "Please first create group as there is no group"). An "Apply" button is located at the bottom right of the dialog.

II. Set the e-mail group

1. Log in the embedded Web server (please refer to [Chapter 6.1](#) for login method).
2. Click "Settings", "Machine Settings" and then "E-mail Group" to enter the setting interface of e-mail group.
3. Click "Create" to pop out a window as below and edit the group name and check the e-mail address to be added in the contact name (e-mail address) listbox, and then click "Apply".

The screenshot shows a dialog box titled "New" with a close button in the top right corner. It contains a "Group name" input field (empty) and a "Contact Name (Email Address)" listbox. The listbox contains one entry: "iceshi(123456@qq.com)" with a checked checkbox to its left. An "Apply" button is located at the bottom right of the dialog.

6.2.3.3. Configure the FTP address book

If you want to scan a file to the FTP server, you need to configure the FTP address book first. When scanning, you may send the image scanned to the FTP server. Before configuring the FTP address book, you may need to ask your network administrator for the

1. Log in the embedded Web server (please refer to [Chapter 6.1](#) for login method).
2. Click "Settings", "Machine Settings" and then "FTP Address Book" to enter the setting interface of FTP address book.
3. Click "Create" to pop out a window as below and set relevant parameters; after settings completed, and then click "Apply".

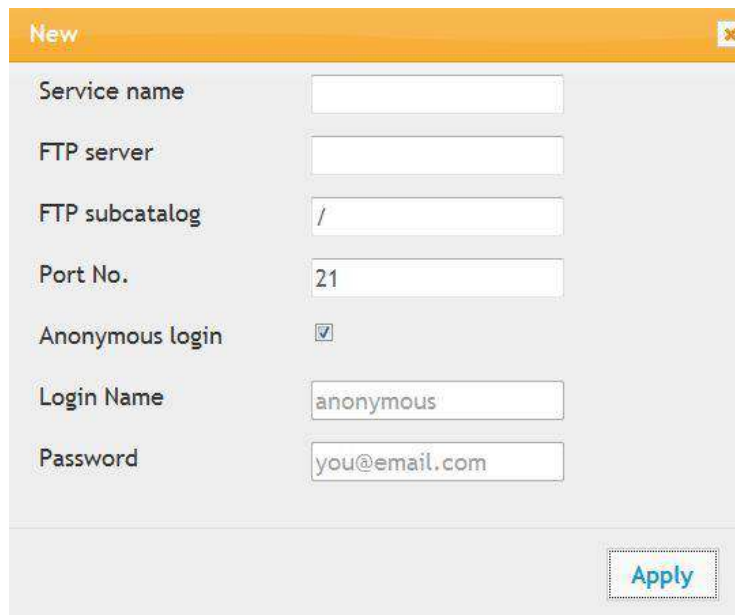

| | |
|-----------------|--|
| Service name | <input type="text"/> |
| FTP server | <input type="text"/> |
| FTP subcatalog | <input type="text" value="/"/> |
| Port No. | <input type="text" value="21"/> |
| Anonymous login | <input checked="" type="checkbox"/> |
| Login Name | <input type="text" value="anonymous"/> |
| Password | <input type="text" value="you@email.com"/> |

Apply

6.2.3.4. Sleep time setup

If you want to change the sleep time of the printer, you can set it via the embedded Web server (the printer installed via network connection).

1. Log in the embedded Web server (please refer to [Chapter 6.1](#) for login method).
2. Click "Settings" – "Machine settings" – "System".
3. Select sleep time according to you need and then click "Apply".

6.2.4. Recover factory settings via Web server

1. Log in the embedded Web server (please refer to [Chapter 6.1](#) for login method).
2. Click “User Management” and then click “Restore to Factory Settings” to recover factory settings. The printer will restart automatically after factory settings recovery is finished.





- Note:** • After factory settings of printer are recovered, user name of the administrator will be recovered to admin and the login password will be recovered to 000000.
- You can also recover factory settings via keys on the control panel of printer, please refer to [Chapter 11.1.4](#).
-

7. Print

7.1. Print Function

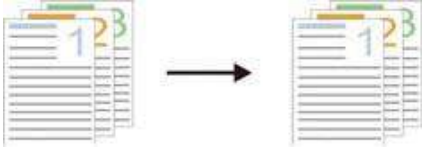
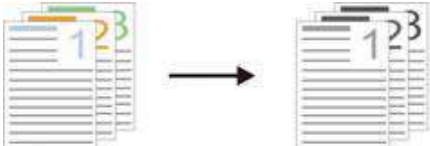
You can set the print function through "Start"->"Devices and Printers"- select corresponding printer- right click – set print function in "Printing preferences". Some functions are as follows:

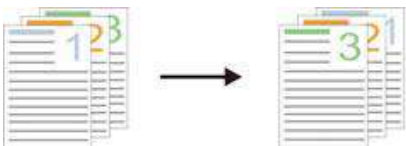
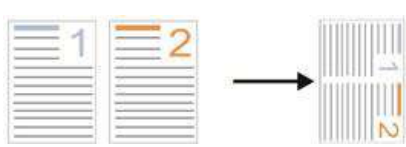
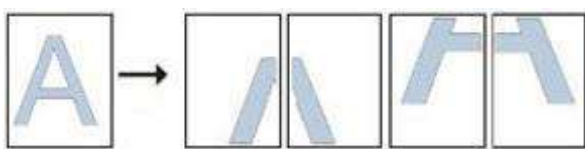
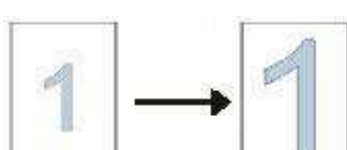
| Functions | Diagram |
|---|--|
| Color Printing ¹ |  |
| Monocolor printing |  |
| Collate Print |  |
| Reverse Print |  |
| N-in-1 |  |
| Poster Print(for Windows Operation System only) |  |
| Zoom Print |  |

Booklet printing



Custom Size



Note: • Windows 7 is taken as example in the above description.

- You can realize poster printing feature by selecting 2x2 poster printing in multipage.
 - You can enable printing preference and click the help button to view detailed function description.(Please refer to [Chapter 7.2.5](#) for the method to open help document).
 - Note 1: When the Cyan (C), Magenta (M) or Yellow (Y) laser toner cartridge cannot be replaced promptly after its life is expired, you can choose to continue printing in black and white.
-

7.2. Print Settings



Note:• Windows 7 is taken as example for the following operation.

7.2.1. Setting the printing parameters

You can set up printing parameters with the following two methods before sending printing work (such as paper type, paper size and paper source).

| Operating system | Temporary printing setup change | Permanent default setup change |
|------------------|---|--|
| Windows 7 | 1. Click “File” menu - “Print” - “Select printer” - “Printer properties” (the detailed steps may differ because of multiple operating systems). | 1. Click “Start” menu- “Control Panel” - “Devices and Printers” . 2. Right click on the printer icon, select “Printing preference” and then change setup and save it. |
| macOS | 1. Click “File” menu - “Print” . 2. Change setup in the window popping out. | 1. Click “File” menu - “Print” . 2. Change setup in the window popping out and click to save the preset. (Select preset every time before printing, or print according to default setup.) |



Note:• Priority of App setup is senior to printer setup.

7.2.2. Print quality settings

7.2.2.1. Print Color

The printer supports color printing, black-and-white printing, and printing text in black. You can change it through the following steps as necessary.

1. Open the file to be printed, click the “File” menu in the upper left corner, and select “Print” to enable the print driver.
2. Select printer of the corresponding model.
3. Click “Printer Properties/Preferences” to configure printing.
4. Enter the “Quality” option interface.
5. Check the print effect you want according to your need.



Note:• If you don't check any one of them, the print effect will be output in color mode.

- If you check “Black & White Printing”, the print effect will be output in black mode.
- If you check “Printing Text in Black”, the print effect will be text printed in black, and graphics and images printed in color. If the application recognizes the font as an image, the printer may print the text in color.

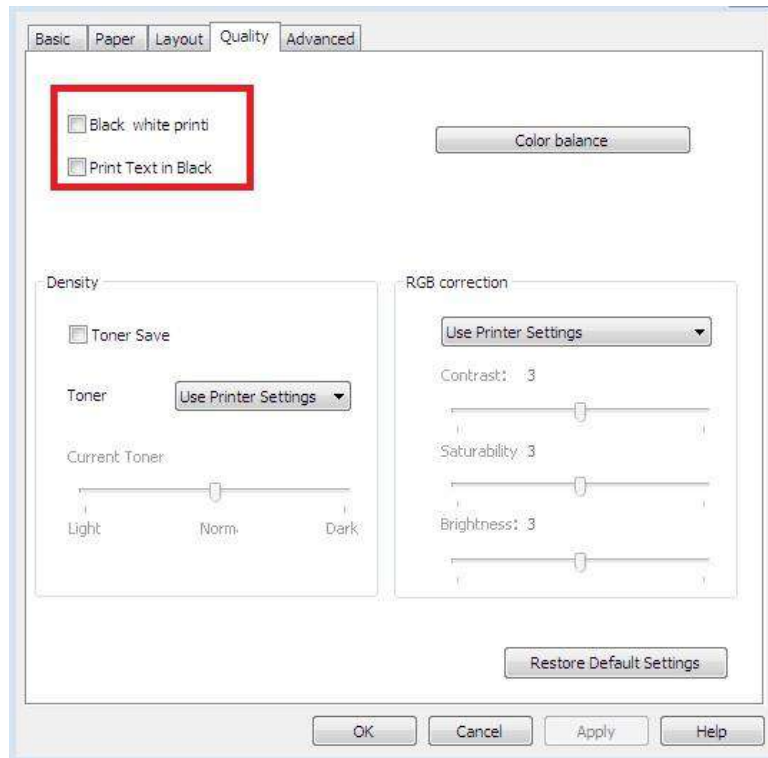

6. Click “OK”/“Apply” in the lower left corner to complete the print settings.

7. Click “Print” to achieve the print effect you want.

7.2.2.2. Color balance

Color balance is used to adjust the amount of toner used for each color. You can change it through the following steps as necessary.

1. Open the file to be printed, click the “File” menu in the upper left corner, and select “Print” to enable the print driver.
2. Select printer of the corresponding model.
3. Click “Printer Properties/Preferences” to configure printing.

4. Enter the “Quality” option interface. Click “Color Balance” .

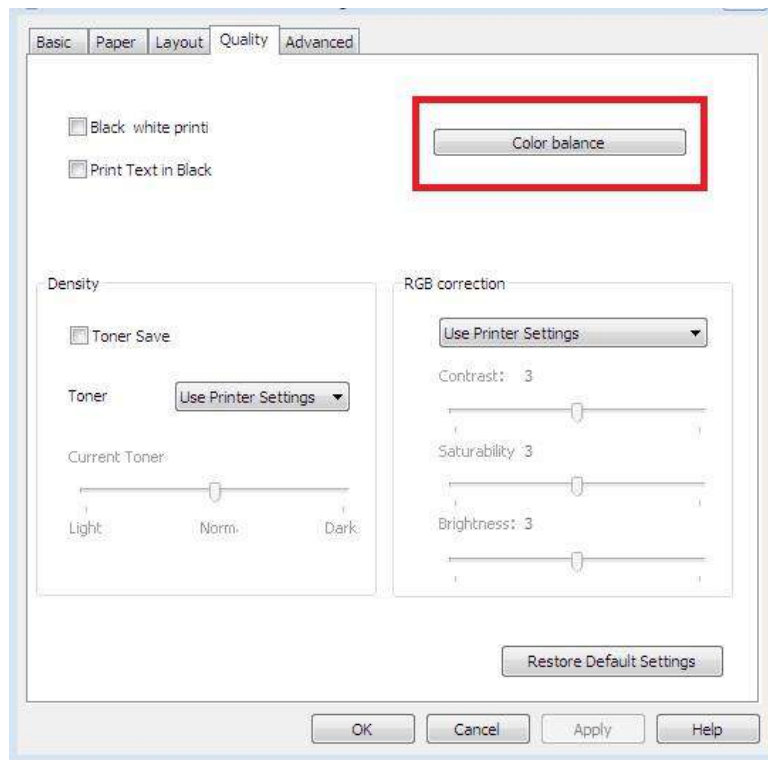

5. Select “Manual” among the options to adjust the parameters for the amount of toner for each color to be used in the printed document.

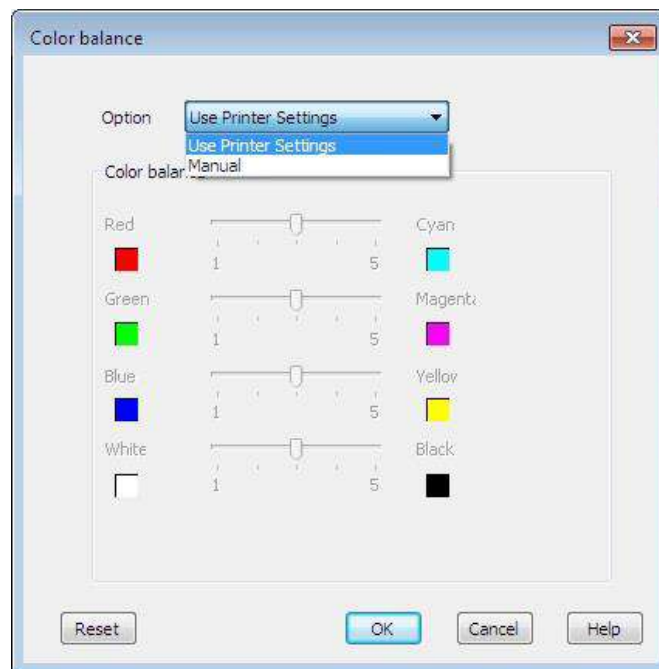



 **Note:** • If you choose “Use Printer Settings”, the parameters in the color balance cannot be adjusted, and the settings specified in the printer are applied.

7.2.2.3. RGB correction

Adjust the contrast, saturability and brightness of the color output. You can change it through the following steps as necessary.

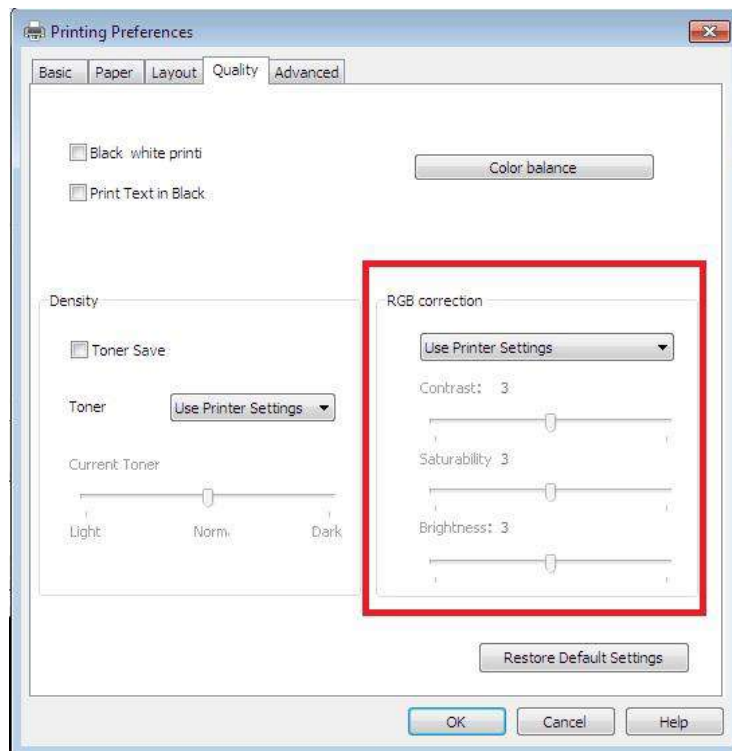
1. Open the file to be printed, click the “File” menu in the upper left corner, and select “Print” to enable the print driver.
2. Select printer of the corresponding model.
3. Click “Printer Properties/Preferences” to configure printing.
4. Enter the “Quality” option interface. In the “RGB Correction” option, select “Manual” to adjust “Brightness”, “Contrast” and “Saturability”.



 **Note:** • If you choose “Use Printer Settings”, you cannot adjust the contrast, saturability, and brightness, and the settings specified in the printer are applied.

7.2.3. Duplex

The printer supports duplex printing of plain paper. Paper size supported by the duplex printing: A4, Letter, Legal, Folio, Oficio.

 **Note:** • Some paper media are not suitable for duplex printing, and trying duplex printing may result in damage to the printer.

- Duplex is not available for poster printing.
- Please refer to [Section 2](#) for loading paper and print media in the tray.

Setting steps:

1. Open the print job to be printed from the application (such as a Notepad).
2. Click the “File” menu in the upper left corner, and select “Print” to enable the print driver.

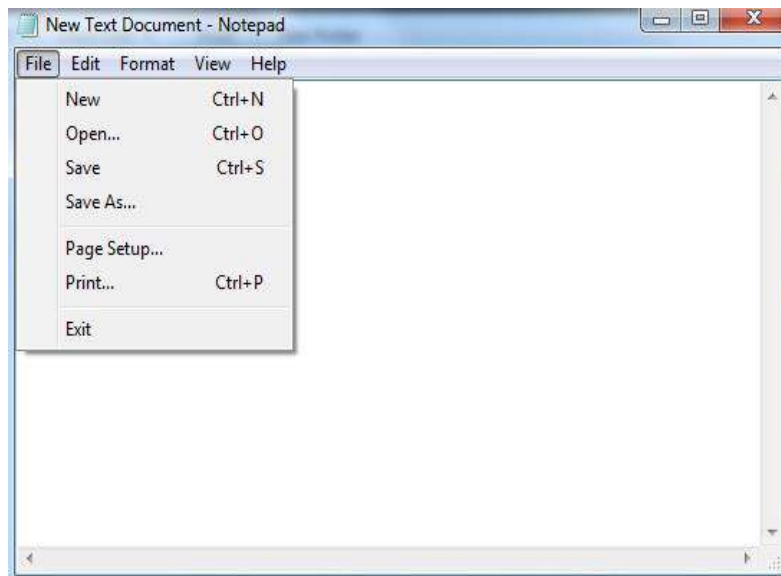

3. Select printer of the corresponding model.

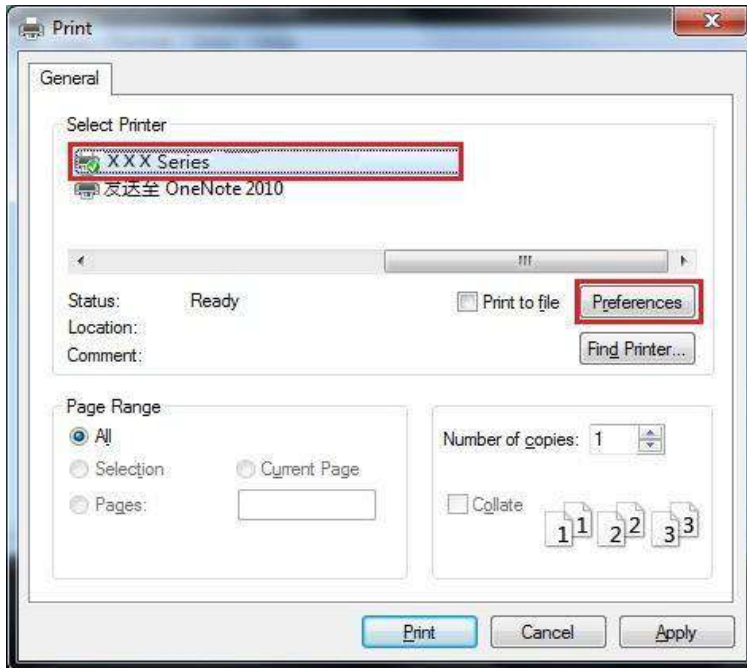

4. Single click “Preferences” for printing setup.

5. Select the “Duplex” in “Basic” tab and then select “Long Edge” or “Short Edge”.

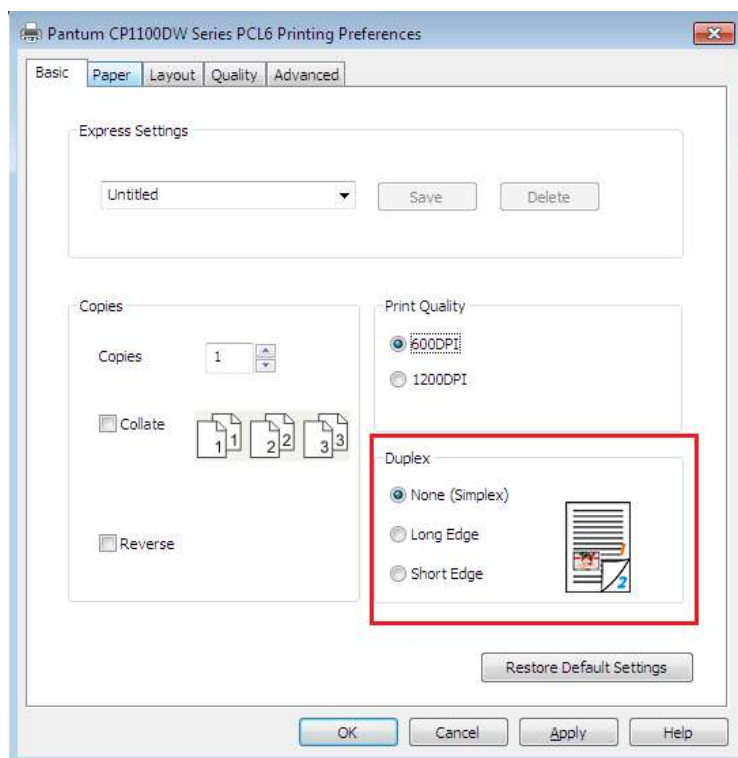

6. Single click “OK” to finish printing setup. Click “Print” to enable duplex printing.

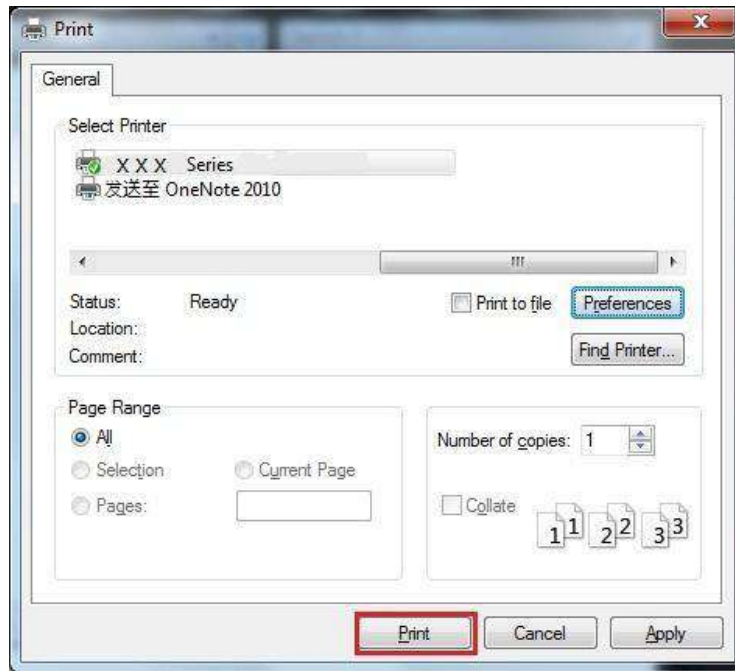

7.2.4. Booklet printing

 **Note:** • "Booklet" cannot be concurrently used with "Multipage" or "Zooming".

- To enable the Booklet function, please also check "collated".
- To start a Booklet, please select any of the following paper types: A4, Letter, Legal, Oficio or Folio.
- Since Booklet always goes with duplex printing, when it is selected, "Duplex" will be checked automatically and cannot be unchecked.

Operating steps for booklet printing:

1. Open the file to be printed, click the "File" menu in the upper left corner, and select "Print" to enable the print driver.
2. Select printer of the corresponding model.
3. Click "Printer Properties/Preferences" to configure printing.
4. Enter the "Layout" option interface and select "Booklet".

 **Note:** • For other settings of booklet printing, click "Booklet Settings...", complete print settings in the "Booklet Settings" interface as needed, and then click "OK".

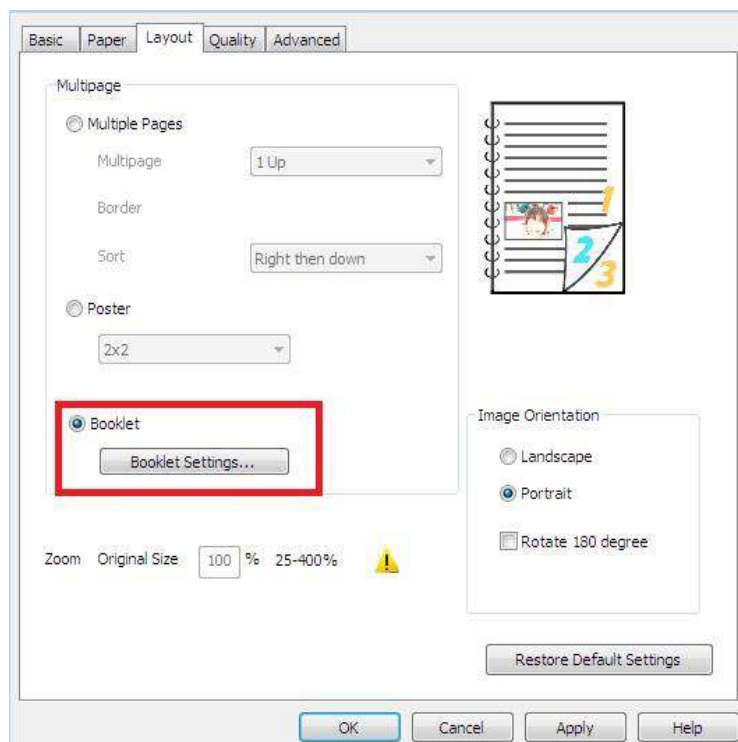

5. Click "OK"/"Apply" to finish printing setup. Click "Print" to print the booklet.

 **Note:** • Documents will be re-paged after selecting booklet printing. It will print two pages on each side of the paper, and then fold out of it to form a book-like booklet.

7.2.5. Set transfer print parameters

If the printed image is mottled or blotchy-looking, you can try to adjust the transfer print parameters through Printer Setup.

The steps are as follows: (Suitable for printers installed via USB connection)

Windows 7 is taken as the example in the following operation. The information on your computer screen may differ because of multiple operating systems.

1. Enter the “Start menu” – “Control Panel” –view “Devices and Printers”.
2. Right click printer and select “Printer properties” in the pull-down menu.
3. Enter “Printer Setup” option.
4. Click “Other Settings” to adjust the transfer print parameters.

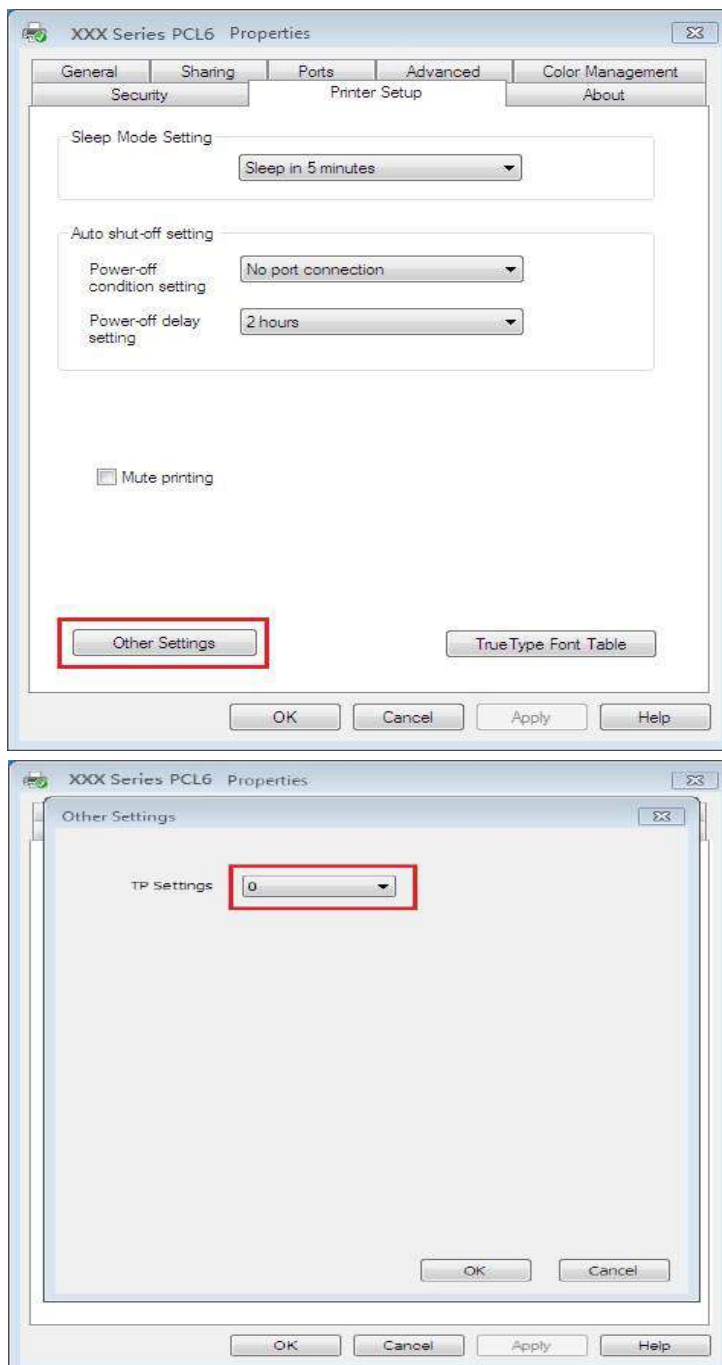

 **Note:** You can also set transfer print parameters through buttons on control panel. Please see [Section 11.2.3](#).

7.2.6. Open Help Document

You can open the "Printing preferences" and click "Help" button (for Windows Operation System only). The help document contains the user guide where you can find the information on print settings.

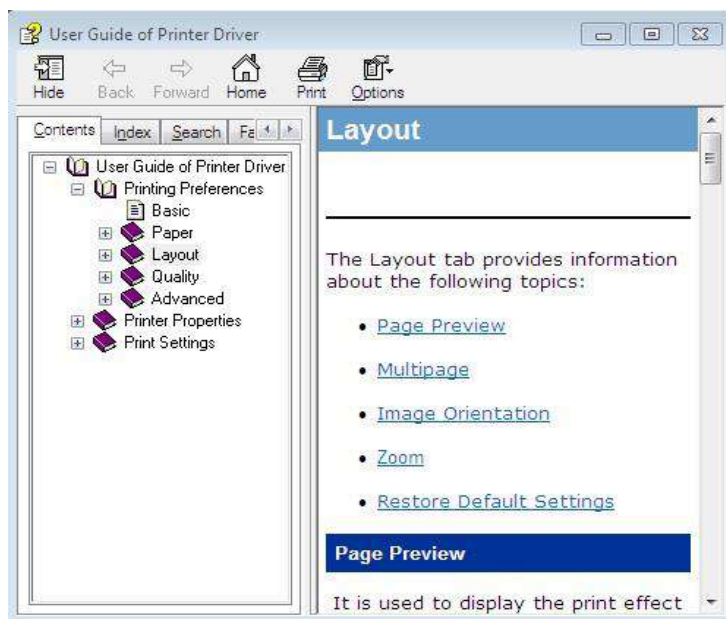
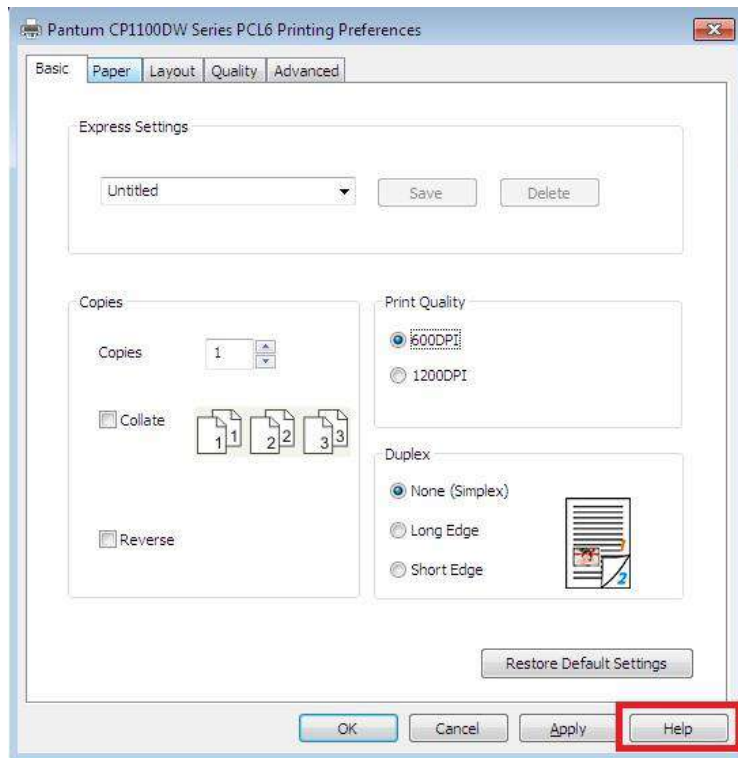

7.3. Printing Mode

The printer can print with auto feed tray and manual feed tray. The defaulted state is auto selection, and if there is printing medium in the manual feed box, papers in manual feed tray will be used with priority.

7.3.1. Printing with the Automatic Feeder Tray

Before printing, please make sure mediums of corresponding quantity have been installed inside the auto feed tray, and there is no printing medium in the manual feed tray.



Note: • For precautions on loading paper, see [Chapter 2](#).

- For the type of media to be printed with the automatic feeder tray, see [Chapter 2.2](#).
-

7.3.2. Printing with manual feed tray

When you put paper into the manual tray, the printer will automatically print with the paper in the manual tray first.



Note: • Only one sheet can be loaded into the manual tray at a time.

- Please refer to [Chapter 2](#) for putting papers inside manual feed tray.
 - Please refer to [Chapter 2.2](#) for type of mediums that can be printed via manual feed tray.
-

7.4. Cancel printing

If you want to cancel the operation during printing, please press “Cancel” key on the printer's control panel.

8. Copying

8.1. Copying function

| Copying function | | Instructions |
|------------------|------------------|--|
| Common copying | Copy source | Set the paper size of the originals. |
| | Copy To | Set the paper size and type of the specified tray. |
| | Resizing | Reduce or enlarge the size of image copied. |
| | Intensity | Adjust deep-light copying effect by setting intensity. |
| | Duplex copying | It supports manual duplex copying for originals. |
| | Color | It is used for color or monochrome copying. |
| | Image quality | Set the definition mode to improve the copying effect. |
| | Multipage | Print a multi-page document to a piece of paper. |
| | Clone | Print several identical images to a piece of paper. |
| | Poster | Print a one-page original to pieces of paper. |
| | Collated copy | Collate copies of an original. |
| ID copy | Arrangement mode | Set the Layout for Copying ID Card |
| | Paper Size | Set the paper size. |
| | Intensity | Adjust deep-light copying effect by setting intensity. |
| | Color | It is used for color or monochrome copying. |
| Receipt copying | Paper Size | Set the paper size. |
| | Intensity | Adjust deep-light copying effect by setting intensity. |
| | Color | It is used for color or monochrome copying. |

8.2. Copying method

1. Press “Copy” / “ID Copy” / “Bill Copy” on the control panel.
2. Put the original on the glass platen, with its front side downward (see [Section 2.5](#) for details).
3. Press “Startup key” for copying.

8.3. Common copying setting

Change related setting through setting menu for better copy result.

1. Press "Copy" and then "Menu" on control panel to enter the "Menu Setting" interface.
2. Press "OK" to enter the "Copy Setting" interface.
3. Press "direction key" to select option to be set and press "OK key" to set option.



Note: • Luminosity. Once the option is set, it will remain effective until it is changed.

- Image Quality, Zoom, N-in-1, Clone, Poster and Duplex Copy settings. When the copying is finished, switch by pressing the button on the panel, or restart the printer, the settings will restore to default.
-

8.3.1. Image quality

Select corresponding image quality mode for original document used in order to improve copying effect.

There are 4 modes in total:

Auto: default mode, applicable to text and image originals.

Text + image: applicable to originals with mixed text and image.

Image: applicable to original image.

Text: applicable to original text.



Note: • If the setting is "Poster", the Image Quality mode only supports automatic adjustment.

8.3.2. Intensity

Adjust deep-light copying effect by setting intensity.

This printer supports "Manual Adjustment" and "Auto Adjustment" in color intensity. 5 levels for manual adjustment and 3 levels for auto adjustment by default.

8.3.3. Resizing

Through zoom setting, the image to be copied can be zoomed by 25%~400% of the original document size.

You can press the arrow key "▲" or "▼" in the "Zoom" - "Manual" interface to decrease or increase the value by 5% per step.



Note: • When the original is in the ADF, manual zooming is not allowed.

8.3.4. Multipage

A 2- or 4-page file can be copied on a piece of paper through N-in-1 setting, and copying with the glass platen is supported.

The multipage includes 3 modes:

(1) Two-in-one:

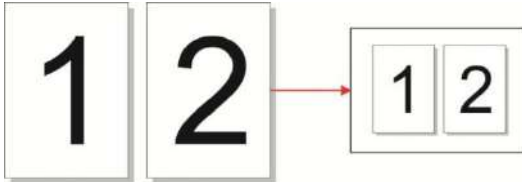

(2) Horizontal four-in-one:

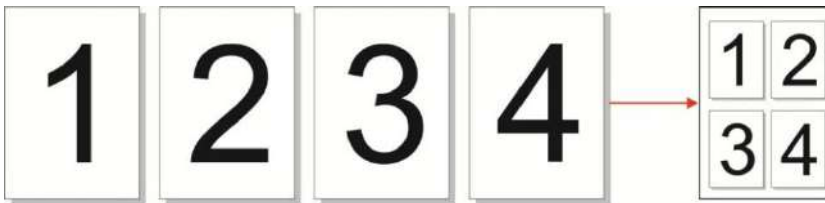

(3) vertical four-in-one:





 **Note:** • "Multipage" and "resizing function" cannot be set at the same time.

8.3.5. Clone

Multiple original images can be printed on a piece of paper through clone setting, and copying with the glass platen is supported.

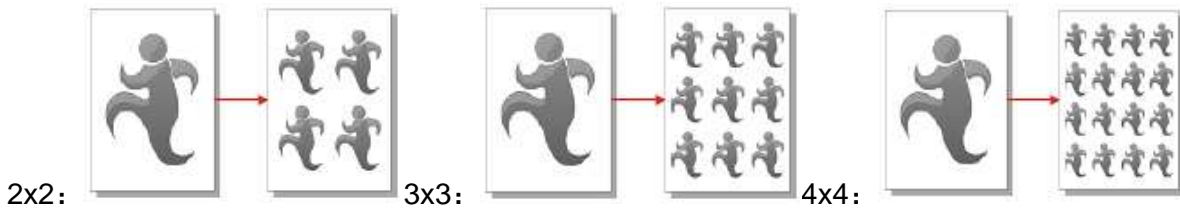
The clone copying includes 3 modes:



 **Note:** • The “clone” and “resizing function” cannot be set at the same time.

8.3.6. Poster

Poster setting enables the printing of one piece of original document on several pieces of paper.

The "Poster" feature supports only copying with the glass platen.

There are 2 poster copy modes:

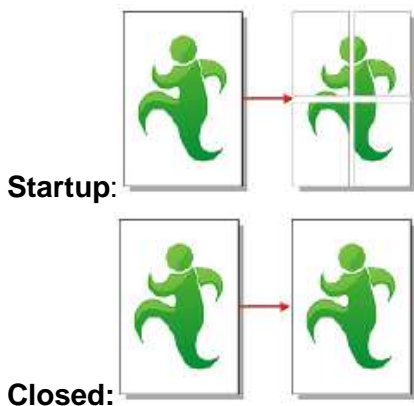

 **Note:** • The “poster” and “resizing function” cannot be set at the same time..

8.3.7. Duplex copy

Put the original into the glass platen with its front side downward, and make sure that there is paper in the tray.

There are 4 modes in total for duplex copying:

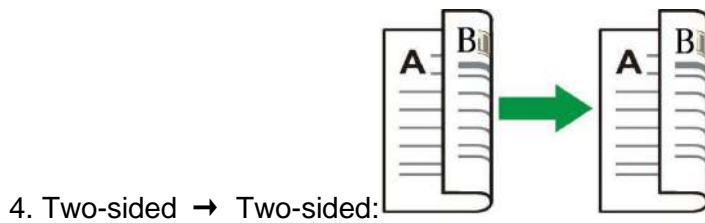
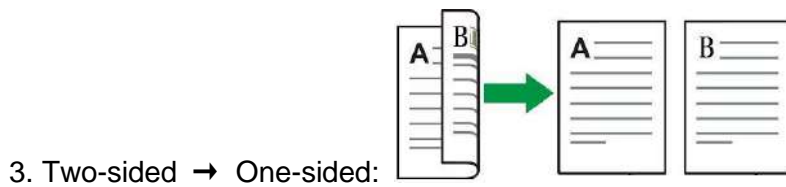
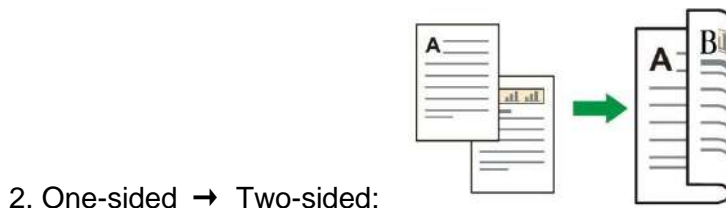
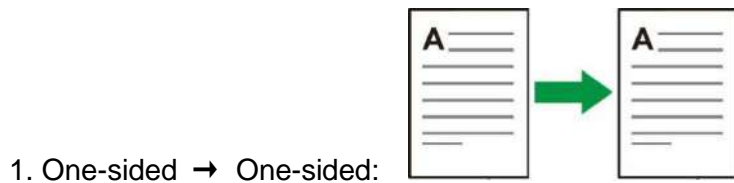

8.3.7.1. Steps to use Manual Duplex Original Copying

Manual Duplex printing steps are as follows. Take “Duplex→Duplex” mode as example.

1. Put the original into the glass platen with its front side downward, and make sure that there is paper in the tray.



2. Follow the steps set forth in [Chapter 8.3](#). Select “Duplex→Duplex” printing mode, press “OK” and save the settings.

3. Press “Start” to begin copying.

4. After copying the first side, open the upper cover of the glass platen, turn the long edge of the original for 180 degrees (with B side down) on the glass platen, and close the upper cover of the glass platen.



Note: • If the turnover prompt on panel times out, the machine will execute one-sided copying automatically..



5. Press "Start" to begin copying the other side.

8.4. ID copy settings

For better copying effects, you can change the corresponding settings via the "ID Copy Settings" menu.

1. Press "ID Copy" and "Menu" on the control panel to enter the "Menu Settings" interface.
2. Press "OK" button and enter "ID Printing Settings" interface.
3. Press "direction key to select option to be set and press "OK key" to set option.

8.4.1. Arrangement mode

ID copy supports four layouts:

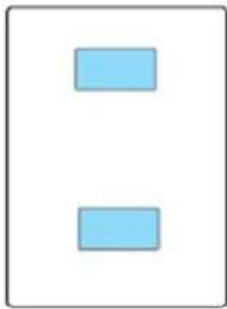

Whole page up-down

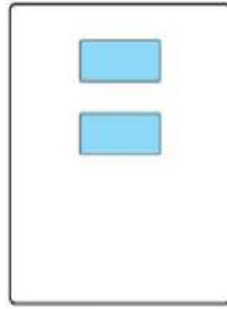

Half page up-down

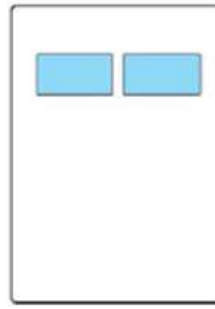

Half page left-right

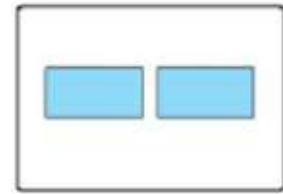



A5 left and right

Position:

Half page up-down: default mode; put ID card at "orange left half area" of glass platform.

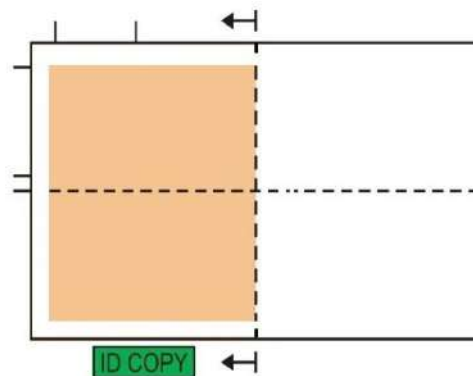
Half-page up and down, half-page left and right or A5 left and right: put the ID card in the "blue area" in glass platen.



 **Note:** • After setting, the arrangement mode can keep valid before startup; after startup, the arrangement mode will recover to default setting.

8.4.2. Intensity

Adjust copy luminosity through “Luminosity” setting.

This printer supports "Manual Adjustment" and "Auto Adjustment" in color intensity. 5 levels for manual adjustment and 3 levels for auto adjustment by default.

8.4.3. Paper dimension

If arranged in modes of "Full Page Up and down", "Half-page Up and down" and "Half-page Left and right", the paper size supports "A4" and "Letter" only; if arranged in mode of "A5 Long Edge", the paper size supports "A5" only. Please follow instructions o

8.5. Receipt setting

For better copying effect of bills, you can enter the "Bill Copy Setting" menu to change relevant settings.

1. Press "Bill Copy" and then "Menu" on control panel to enter the "Menu Settings" interface.
2. Press "OK" to enter the "Bill Copy Setting" interface.
3. Press “direction key to select option to be set and press “OK key” to set option.

8.5.1. Intensity

Adjust copy luminosity through “Luminosity” setting.

This printer supports "Manual Adjustment" and "Auto Adjustment" in color intensity. 5 levels for manual adjustment and 3 levels for auto adjustment by default.

8.5.2. Paper dimension

The receipt copying supports A4, Letter, B5, A5, A6 and Executive paper dimension.

8.6. Copying cancel

Press “cancel key” on control panel if canceling copying.

9. Scan

This printer provides two types of scan: "Push Scan", which means scanning through the printer's Control Panel operations; "Pull Scan" which means scanning through PC terminal scanning the application. Before scanning, please be sure a printer driver has

9.1. Scanning mode

9.1.1. Windows system scan

You may scan with the scanning application in PC via USB, wired or wireless connection. Please be sure the printer has been properly connected before scanning.

9.1.1.1. Pantum Scan Application

Operation Steps:

1. Double click on "Pantum Scan Application" on the computer, the icon is shown as below:



The prompt window is shown as below:

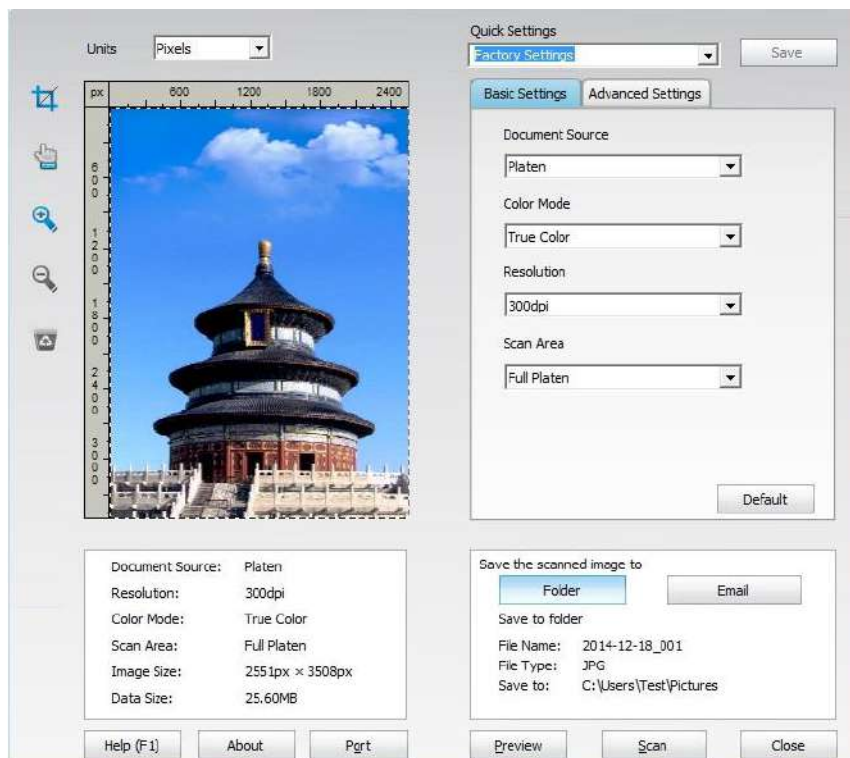

2. Set Scan in the right list. Click "Scan" on the bottom right corner and start scan.



Note:• Images scanned by Pantum scanning application software support six file types: BMP, JPG, TIF, PDF, PNG and OFD.

- You may click "Help (F1)" to open the help document of the scanning application to learn more scanning setting information.
-

his product complies with the TWAIN and Windows Image Application (WIA) standard. If using the application which supports TWAIN and WIA standard, users can use the scan function and directly scan the images to the open application. The handbook requires O

9.1.1.2. TWAIN Scan Driver

9.1.1.2.1. Office Software (Word and Excel)

Operation Steps:

1. Open the Office software (Word or Excel).
2. Keyboard shortcuts: Alt+I+P+S to open the application's window.

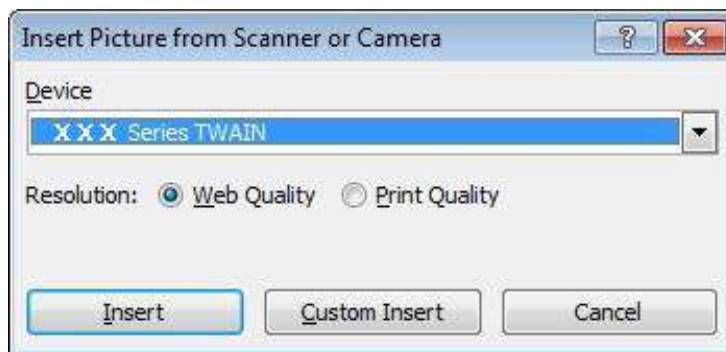

3. Click on "Device" option and select TWAIN Scan, click the "Custom Insert" button below.

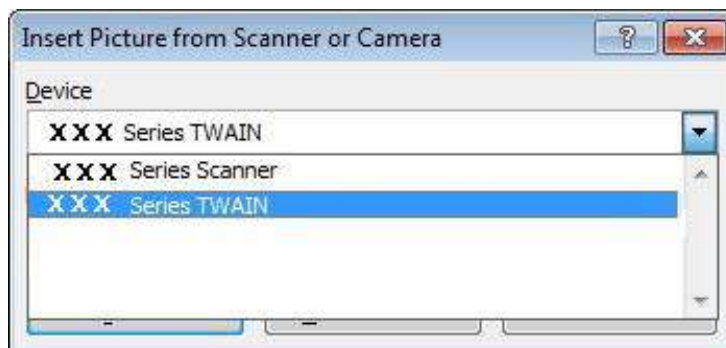

4. After the window pops up, set the scan information in the right list of "Basic Setting" and "Advanced Setting". Click on "Scan" and start scan.

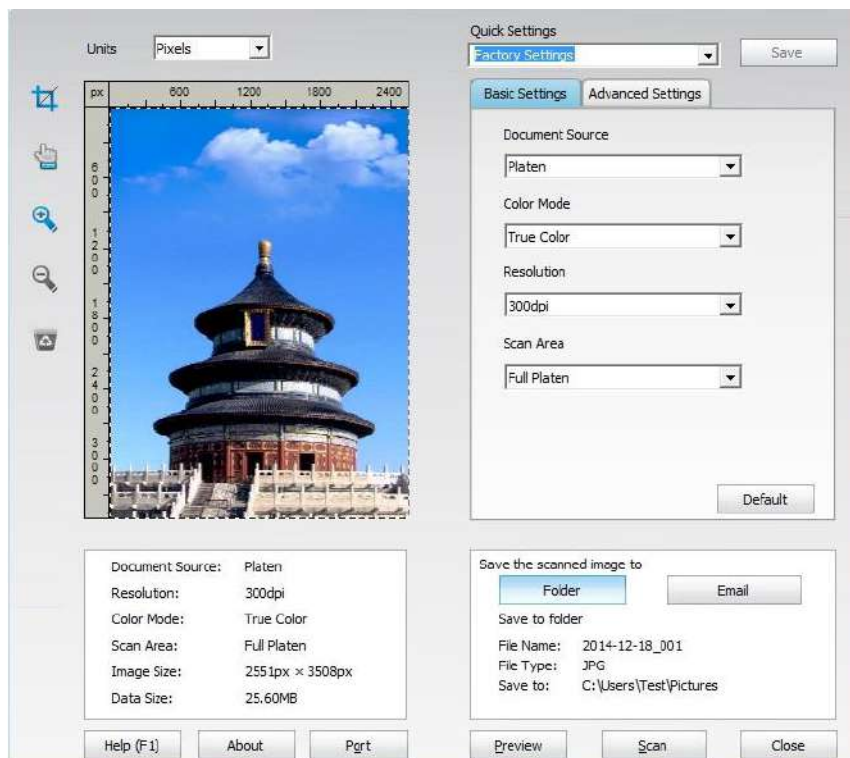

If you desire to change a scanning port, please click "Port" at the lower part of above picture to select a scanning port, as shown below:

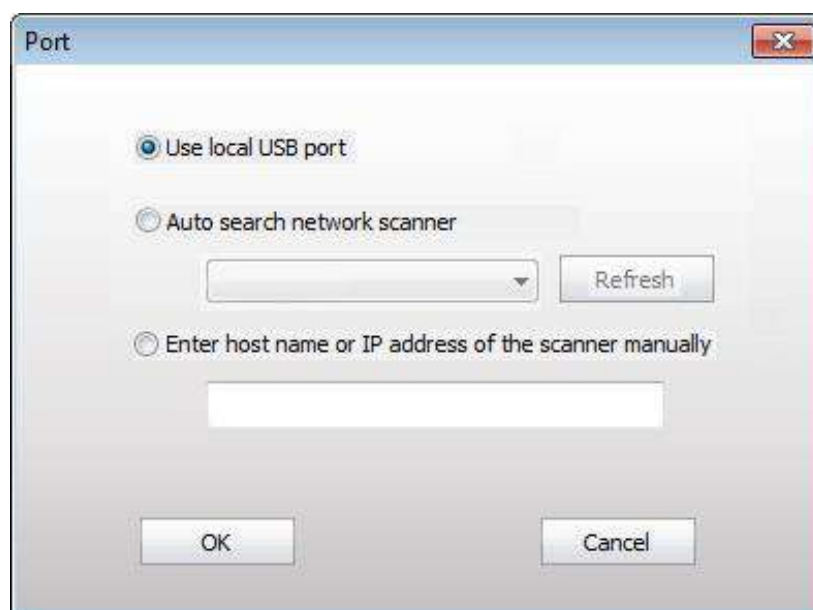

9.1.1.2.2. Photoshop

Operation Steps:

1. Launch Photoshop, click on "File" – "Import" on the top left corner and select TWAIN Scan, as is shown below:

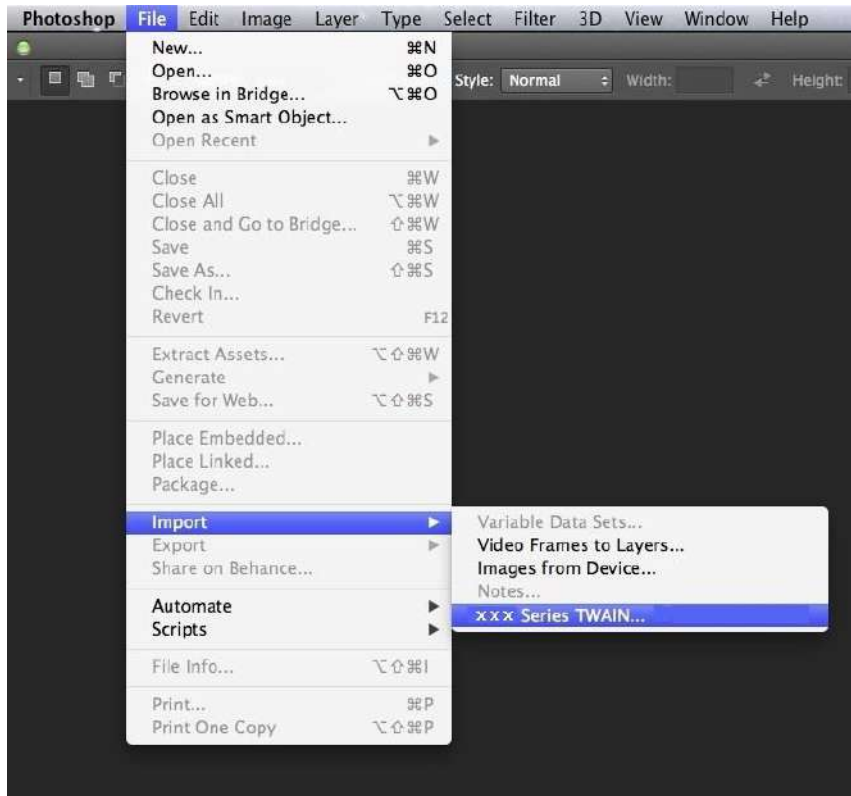

2. After the window pops up, please refer to Step 4 of [9.1.1.2.1](#) to see the specific operation steps.

9.1.1.3. WIA Scan Driver

9.1.1.3.1. WIA1.0 Scan (Windows XP / Windows Server 2003)

1. Office Software (Word and Excel)

Operation Steps:

1) Open the Office software (Word or Excel).

2) Keyboard shortcuts: Alt+I+P+S to open the application's window.

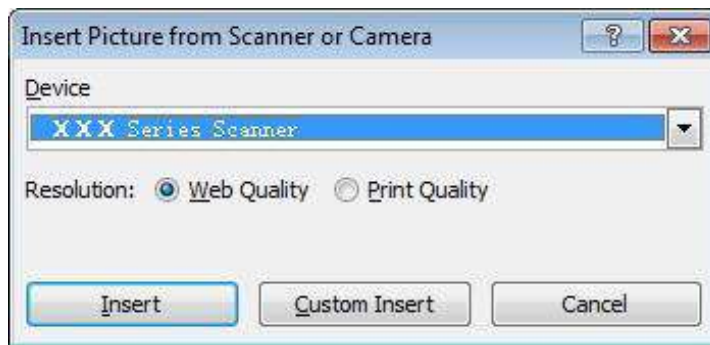

3) Click on "Device" and select WIA Scan, click the "Custom Insert" below.

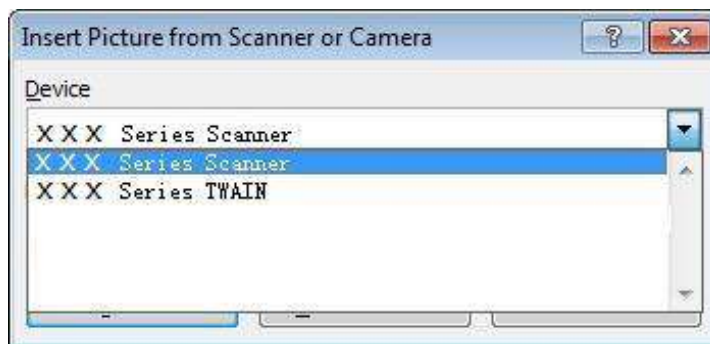

4) The prompt window as is shown below, set the scan information.



5) Click on "Adjust the Scanned Image Quality" on the bottom left corner of the above picture, the advanced properties interface will pop up, then users can set the scan; After finishing the settings, click on the "OK"

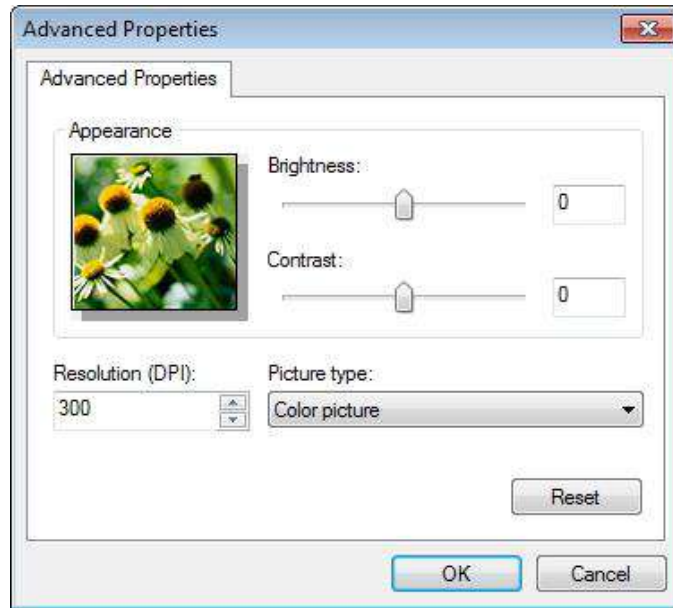

2. Photoshop

Operation Steps:

1) Launch Photoshop, click "File"- "Import" on the top left corner and select WIA Scan, as is shown below:

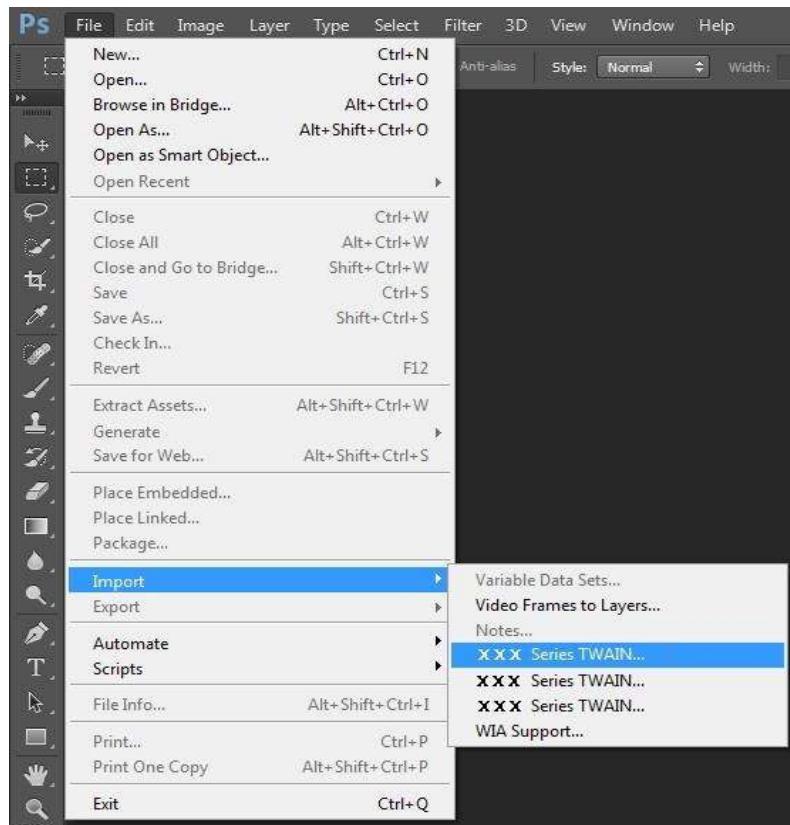

2) After the window pops up, please refer to Step 4 and Step 5 of [9.1.1.3.1](#) to see the specific operation steps.

9.1.1.3.2. WIA 2.0 Scan (Windows Vista / Windows Server 2008 and later versions)

Operation Steps:

1. Click on "Start"- "All Programs"- "Device and Printer" on the left bottom of the desktop.

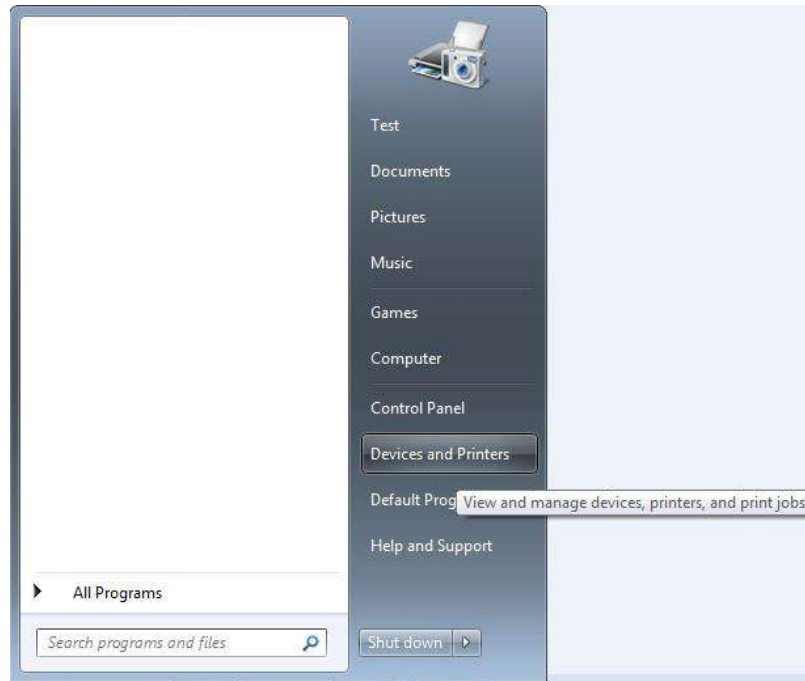

2. When the pop-up window appears, select the printer you want to use, and right click the mouse.

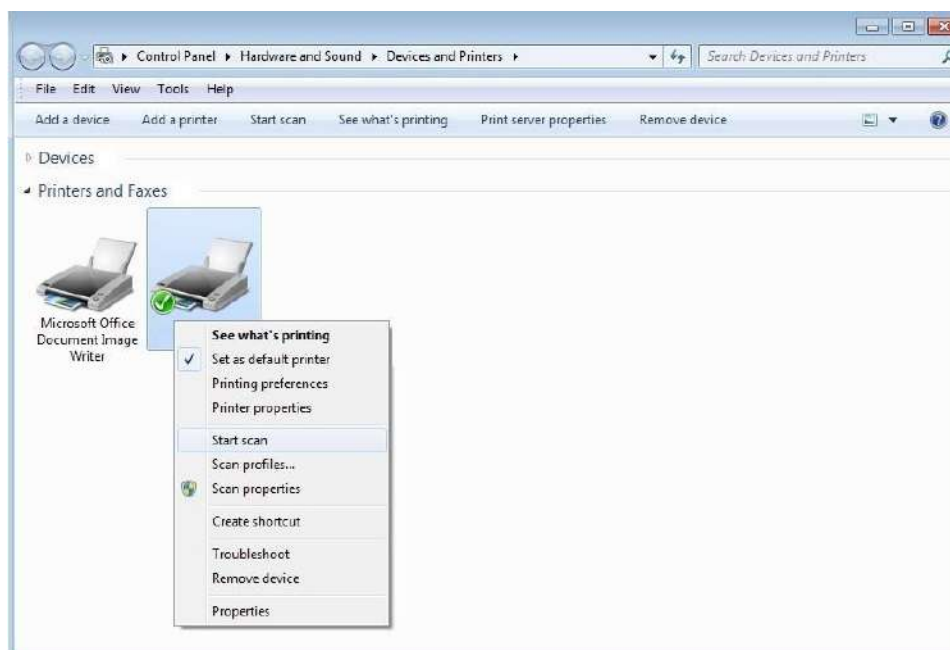

3. Click on "Start Scan" in the above option bar.

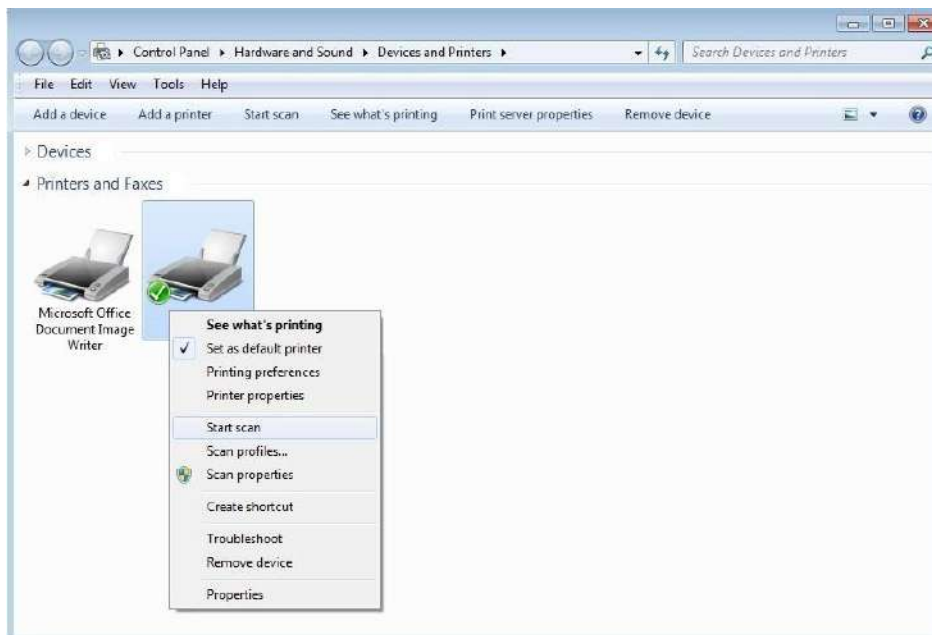

4. After the window pops up, set the scan and click "Scan" on the bottom right corner and start scan.

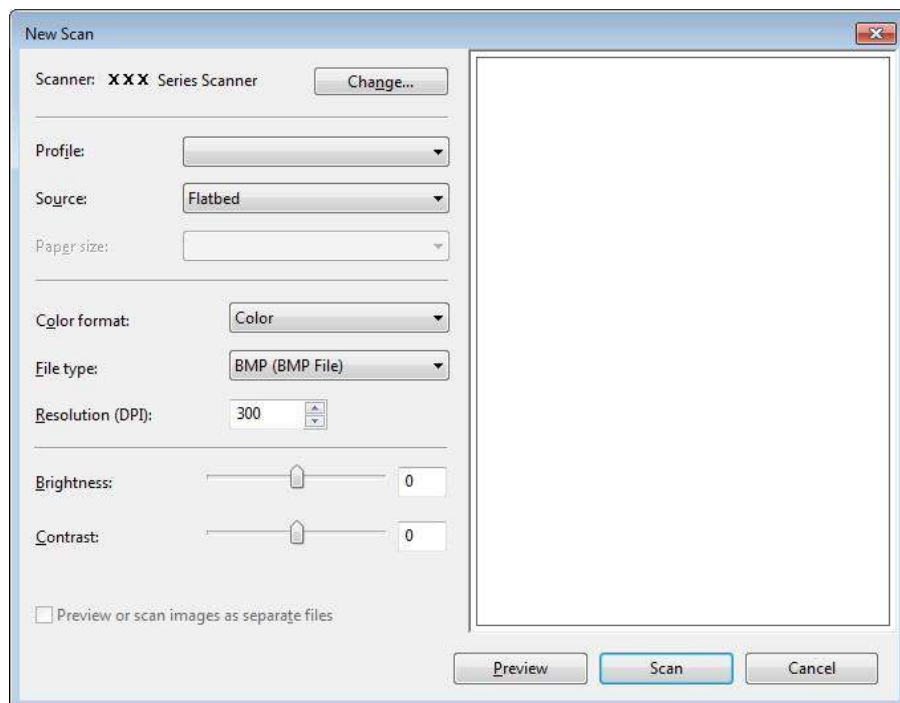

9.1.2. macOS System Scan

9.1.2.1. ICA Scan

9.1.2.1.1. Open ICA via "Print and Scan"

Operation Steps:

1. After installing the printer driver, click "System Preferences" icon on the bottom left corner of the computer desktop.



2. After the window pops up, click on "Print and Scan".

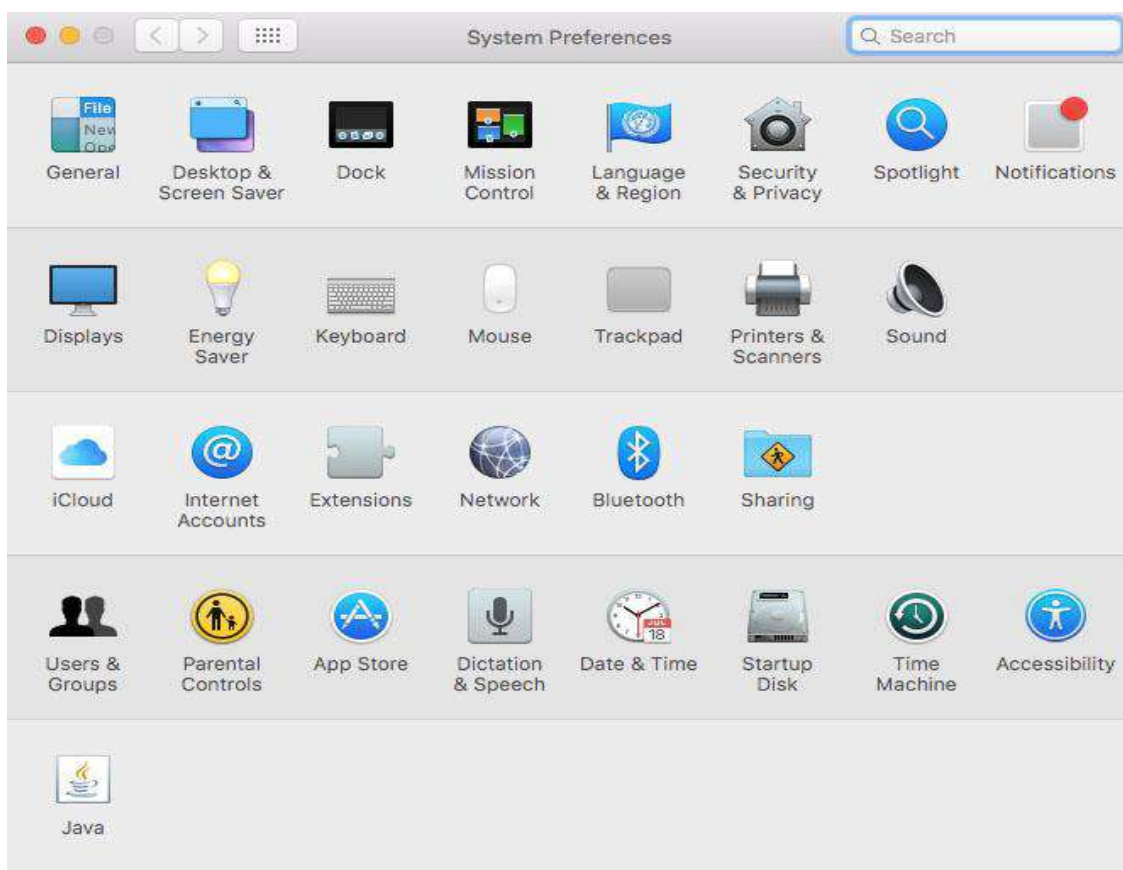

3. After the window pops up, click on "Scan".

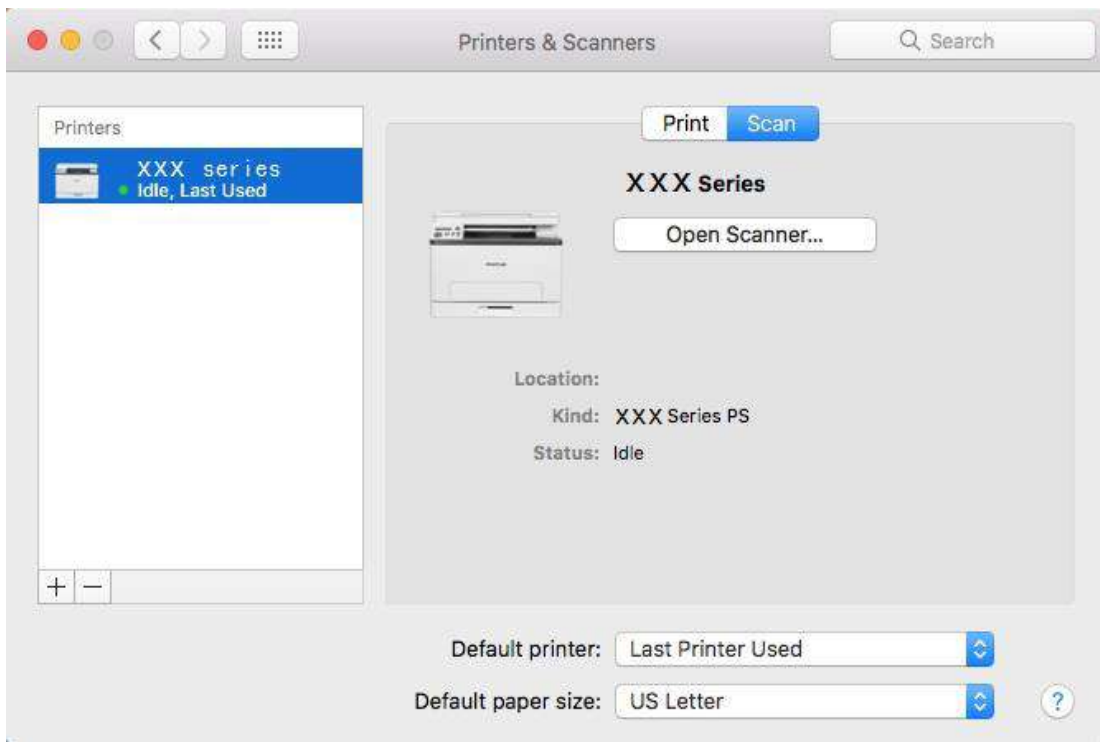

4. Click on "Open Scanner" and the scan window will pop up.

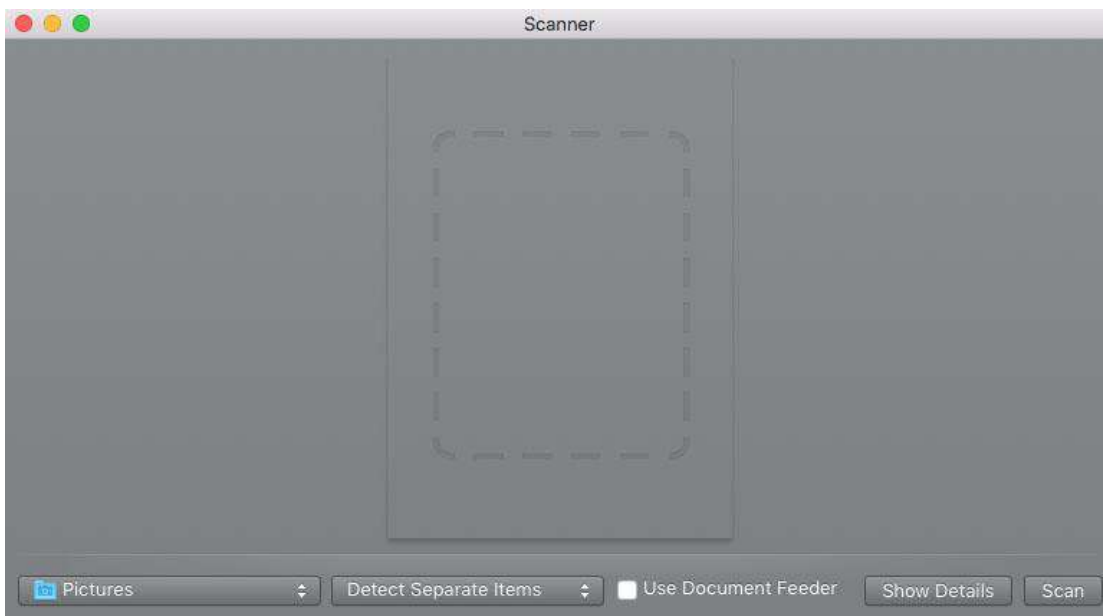

5. Click on "Show Details" on the bottom right corner to set the scan parameters.



6. Click on "Scan" on the bottom right corner and start scan.

9.1.2.1.2. Call CIA through applications

Operation Steps:

1. Click on "Finder" icon on the bottom left corner of the computer desktop, or use keyboard shortcuts command+shift+C to open the window. Find "Image Capture" in "Applications" (or conduct keyboard shortcuts command+shift+A to directly switch to "Applicatio



2. After selecting the printer in the left list, set the scan parameters in the right list. Click on "Scan" on the bottom right corner and start scan.

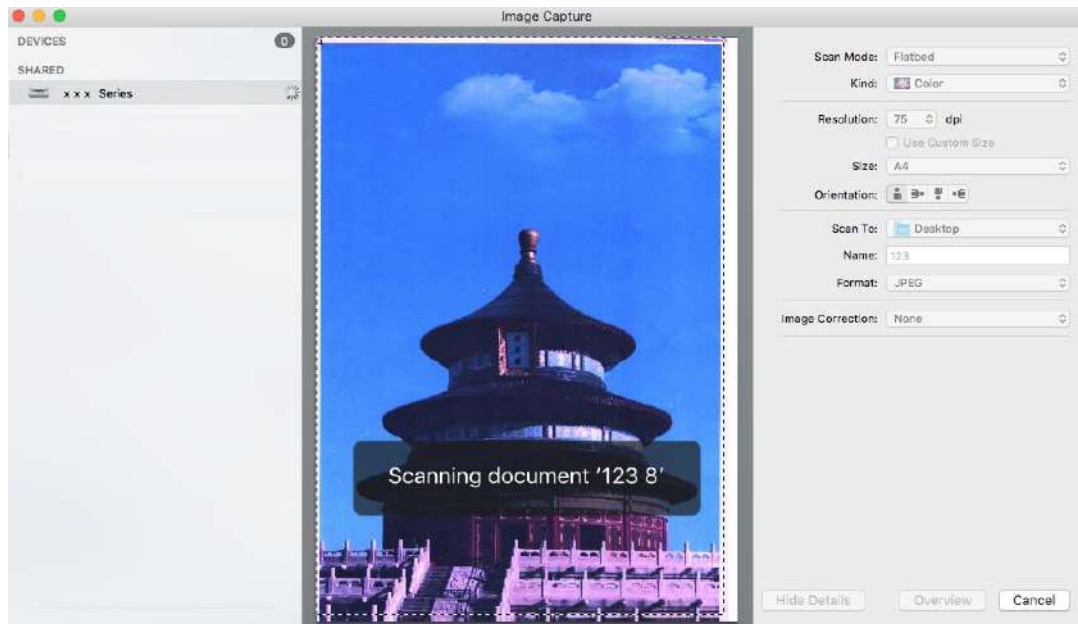

9.1.2.2. TWAIN Scan

Take Photoshop as an example.

Operation Steps:

1. Launch Photoshop, click on "File" – "Import" on the top left corner and select TWAIN Scan, as is shown below:

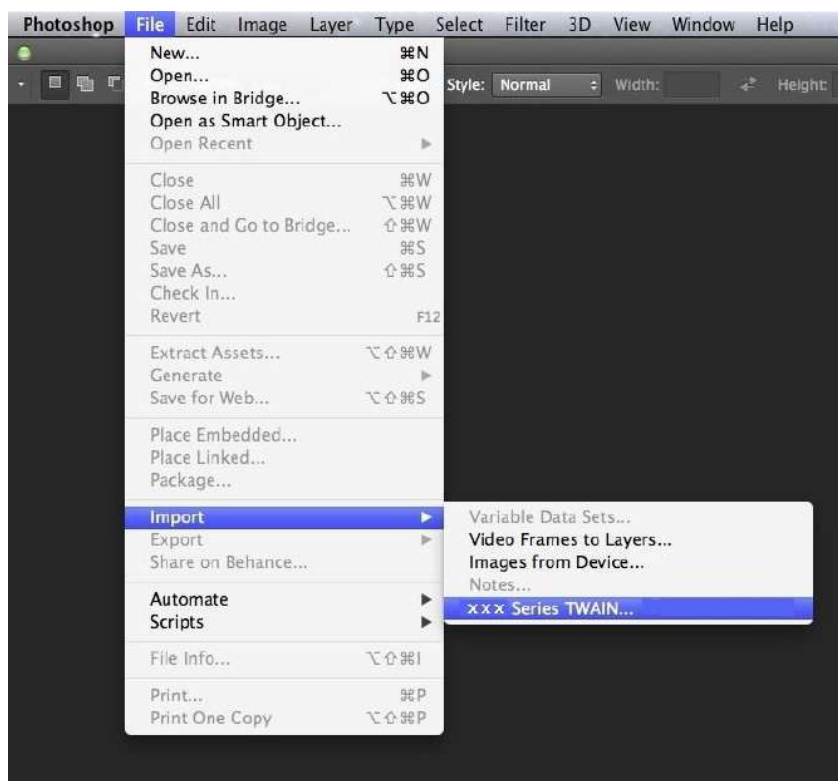

2. After the window pops up, please refer to Step 4 of [9.1.1.2.1](#) to see the specific operation steps.

9.1.3. Push Scan

This section introduces how to scan documents into the PC, Email and FTP through the control panel of the printer.



Note: • Supported file types to be scanned to PC/Email/FTP: PDF, TIFF, JPEG.

9.1.3.1. Scan to PC

You may operate the printer's control panel to scan a file to PC. (Only support connection method of USB connection line.)

1. Be sure the printer and the computer are both switched on and connected with each other properly.
2. Put the original on the glass platen (see [Section 2.5](#) for details).
3. Press "Scan" on the control panel to enter the scanning interface.
4. Select "Scan to PC", then press "OK".
5. Press "Menu" and then "OK" to enter the "Scan Setting" interface.
6. Select scanning parameters according to your needs, then press "Start" to start scanning.

9.1.3.2. Scan to E-mail

You can scan the file as an attachment into the email application. The steps are as follows:

1. Make sure that the printer and computer have been turned on and connected to the same network.
2. Please see [Chapter 6.2.3.1](#) to configure the SMTP Client.
3. Please see [Chapter 6.2.3.2](#) to configure the e-mail address book.
4. Put the original on the glass platen (see [Section 2.5](#) for details).
5. Press "Scan" on the control panel to enter the scanning interface.
6. Press "▲" or "▼" to select "Scan to E-mail" and press "OK" button.
7. Press "▲" or "▼" to select "E-mail Address Book" or "Group Mail" and press "OK" button.
8. Press "▲" or "▼" to select an address or group, then press "OK" .
9. Press "Menu" and then "OK" to enter the "Scan Setting" interface.
10. Select scanning parameters according to your needs, then press "Start" to start scanning.

Please follow these instructions on the settings for group emails:

Set the group name for group e-mail sending by webpage, and set the members, i.e.the receivers, in the group of group email. After finishing scanning, firmware will send the scanned documents to the mail server. Then mail server sends the documents to eve

9.1.3.3. Scan to FTP

Be sure the user is in an Internet-connected environment in scanning files to FTP server. If you want to scan large files, you may need to input the server address, user name and password to log in the server, with specific operation steps as below:

1. Make sure that the printer and computer have been turned on and connected to the same network.
2. Please see [Chapter 6.2.3.3](#) to configure the FTP address book.
3. Put the original on the glass platen (see [Section 2.5](#) for details).
4. Press "Scan" on the control panel to enter the scanning interface.
5. Press "▲" or "▼" to select "Scan to FTP" - "FTP Address Book", then press "OK".
6. Press "▲" or "▼" to select the server, then press "OK".
7. Press "Menu" and then "OK" to enter the "Scan Setting" interface.
8. Select scanning parameters according to your needs, then press "Start" to start scanning.

9.2. Cancel scanning

During the scanning, two ways are available to cancel the job:

1. Press "Cancel" button on the control panel to cancel the job.
2. Click Cancel button on the scan progress bar interface of the computer to cancel the job.

10. Mobile Print/Scan (for models with WiFi function only)

 **Note:** • Some functions are not available depending on different printer models. If you have any questions, please contact the Customer Service.

10.1. "Pantum" APP

"Pantum App" is a free application supporting mobile printing and scanning functions. You can print documents, photos and web pages, or scan photos and documents directly from the mobile terminal. Your printer may not support all of the above functions, please use the relevant functions of the "Pantum App" according to your model. Please make sure that the application has been installed before use and wireless network correctly connected.

10.1.1. Operating systems supported

"Pantum Print" APP is applicable to Android OS 5.1-10.0, and iOS 9.0-14.0 or later.

10.1.2. How to download Pantum App

How to download it for Android mobile device:

1. You can click "APP" in the upper right corner on the web page <http://www.pantum.com> to view details and check, download and install the APP.
2. You can use Google Play Store > Apps > to search Pantum Mobile Printing > Download and install.

How to download it for iOS mobile device:

Click the App Store icon > Search interface > input "PANTUM" or "Pantum print" in the search bar > Download and install on the interface of iOS device to download.

10.1.3. How to use this "Pantum" APP

10.1.3.1. For Android Devices

10.1.3.1.1. Preliminary preparations

1. A printer that has wireless network function.
2. Android mobile device.

10.1.3.1.2. Operation steps

1. Turn on printer power.
2. For an Android mobile device, tap the “PANTUM” icon on the main screen to enter the first interface of “PANTUM”.
3. Select the connection method according to your habit to connect the printer.
4. Select the function you need and set it up to meet your function needs.



Note:• If printing fails, please inspect if the Android device is connected to the wireless network where the printer is connected to.

- If the Android mobile device did not detect any printer, check whether the printer is powered on and the printer is turned on.
 - For more details, please refer to the mobile print user guide attached.
-

10.1.3.2. For iOS Devices

10.1.3.2.1. Preliminary preparations

1. A printer that has wireless network function.
2. iOS mobile device.

10.1.3.2.2. Operation steps

1. Turn on printer power.
2. For an iOS mobile device, tap the “PANTUM” icon on the main screen to enter the first interface of “PANTUM”.
3. Select the connection method according to your habit to connect the printer.
4. Select the function you need and set it up to meet your function needs.



Note:• If printing fails, please inspect if the iOS device is connected to the wireless network where the printer is connected to.

- If the iOS mobile device did not detect any printer, check whether the printer is powered on and the printer is turned on.
 - For more details, please refer to the mobile print user guide attached.
-

10.2. Mopria mobile print

Mopria mobile print requires installing Mopria Print Service on the Android device. You can print photos, emails, webpages and files.

10.2.1. The operating systems and applications which support Mopria mobile printing

1. Mopria mobile printing is suitable for Android 4.4 or higher version.
2. Mopria mobile printing is supported by applications, e.g. Microsoft Office 1.01 (16.0.4201.1006) or higher version, Adobe Reader (V11.7.1) or higher version.

For more information about applications which support Mopria printing, please visit:

<http://mopria.org/spotlight-wall> .

10.2.2. How to download Mopria Print Service

1. Download Mopria Print Service from Google Play and install it on the Android device.
2. For Chinese users, please download the Mopria printing service at <http://cn.mopria.org> for downloading and installing this APP.

10.2.3. Preliminary preparations

1. A printer that has wireless network function.
2. Android mobile device.

10.2.4. How to use Mopria mobile printing

Before printing, please set the Mopria print service as "On".

1. Tap the "Settings" of the Home Screen on Android mobile device, and select "Print".
2. Set the "Mopria print service" as "On".

All other printing plug-ins should be shut down when you use Mopria mobile printing function. The printing steps may vary by applications, taking Adobe Reader as an example for explanation.

1. Turn on printer power.
2. Connect the Android mobile device with wireless network of the printer (Please refer to [Chapter 5](#) for how to connect).
3. Open the files you need to print with Adobe Reader on the Android device.
4. Click  .
5. Tap "Print".
6. Please make sure the Pantum printer is selected.

If you selected other printer (or failed to select any printer), please tap the pull-down menu of printer, and select your Pantum printer.

7. Set printing parameters, e.g. print pages.

8. Tap "Print".



Note: • If printing fails, please inspect if the Android device is connected to the wireless network where the printer is connected to.

- If the Android mobile device did not detect any printer, check whether the printer is powered on and the printer is turned on.
-

10.3. AirPrint mobile print

Only printers that support AirPrint function can realize AirPrint printing. Please check if there is AirPrint mark on the packaging of the printer, in order to identify if the printer supports AirPrint function.

10.3.1. Operating systems supported by AirPrint mobile print

Applicable to iOS 7.0 or higher versions.

10.3.2. Preliminary preparations

1. A printer that has wireless network function.
2. iOS mobile device.

10.3.3. How to use AirPrint mobile printing

The printing steps may varied by applications, taking PDF as an example for explanation.

1. Turn on printer power.
2. Connect the iOS mobile device with wireless network of the printer (Please refer to [Chapter 5](#) for how to connect).
3. Open the files you need to print in the format of PDF on the iOS device.
4. Click .
5. Tap "Print".
6. Please make sure the Pantum printer is selected.

If you select other printers (or no printer), please click printer option and then select your Pantum printer.

7. Set printing parameters such as number of copies to print.
8. Tap "Print".



Note: • If printing fails, please inspect if the iOS device is connected to the wireless network where the printer is connected to.

- If the iOS mobile device did not detect any printer, check whether the printer is powered on and the printer is turned on.
-

11. General Settings

This Chapter mainly introduces some general settings.

 **Note:**• The panel appearance may be a little different due to difference in type or function. All diagrams are only for reference.

11.1. System Setting

11.1.1. Language Setting

Language Setting is used to select the language to be displayed on the control panel.

1. Press "Menu" to enter the menu setting interface.
2. Press "▲" or "▼" to select "System Setting" and then press "OK".
3. Press "▲" or "▼" to select "Language set" and then press "OK" to do language setting.

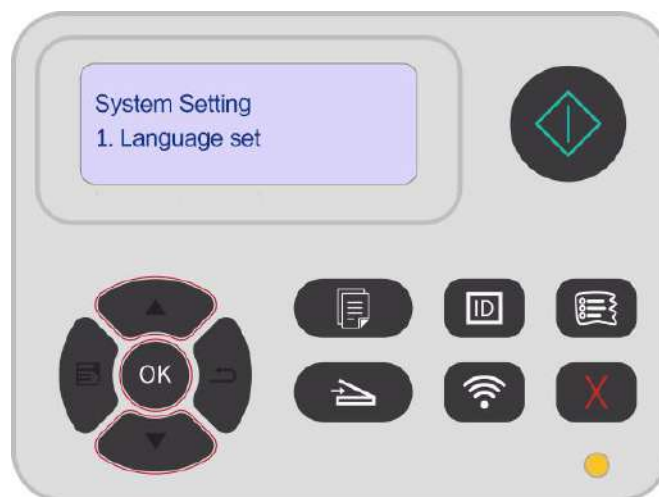

11.1.2. Sleep Time Setting

Sleep mode can reduce the energy consumption of printer effectively, and "Sleep time setting" can be made in the idle time before the device enters sleep mode.

1. Press "Menu" to enter the menu setting interface.
2. Press "▲" or "▼" to select "System Setting" and then press "OK".
3. Press direction key "▲" or "▼" to select "Sleep time set" option, and press "OK" key to set the corresponding sleep time.



Note: • When the printer is in sleep mode, press any button to wake it up.

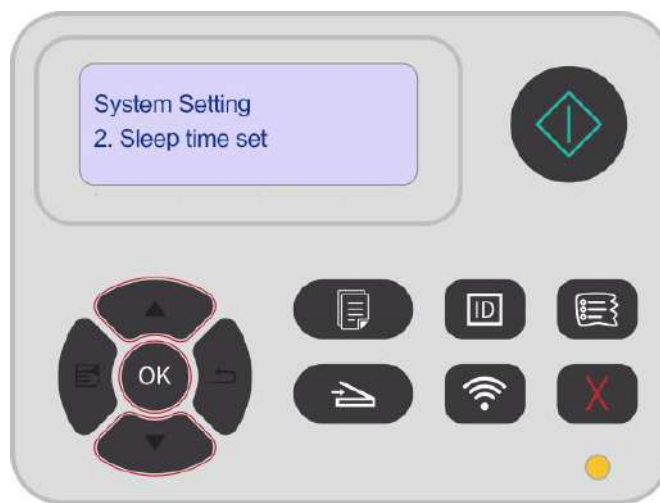

11.1.3. Ink saving setting

You can select the save toner mode which can reduce toner consumption and reduce printing cost. When save toner mode is “on”, the printed color will be lighter. Save toner mode is “off” by default.

1. Press "Menu" to enter the menu setting interface.
2. Press "▲" or "▼" to select "System Setting" and then press "OK".
3. Select “Toner save set” by pressing “▲” or “▼” , and press “OK” to enter the toner saving mode.

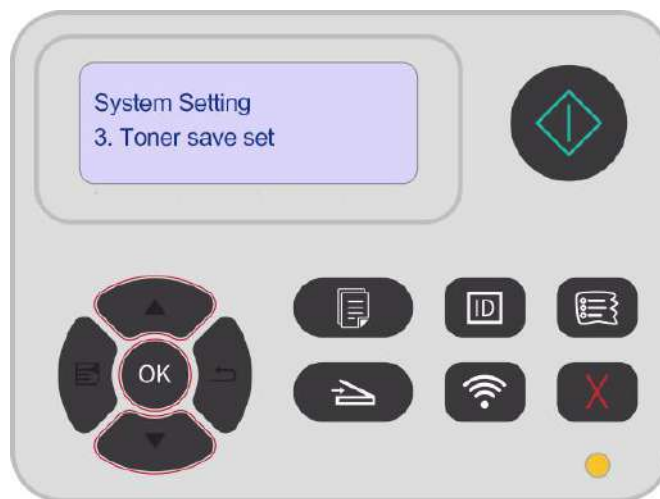

11.1.4. Restore Factory Settings

“Restore factory settings” is used to recover the default settings of printer. The printer will restart itself automatically after recovering factory settings.

1. Press "Menu" to enter the menu setting interface.
2. Press "▲" or "▼" to select "System Setting" and then press "OK".
3. Select “Restore set” by pressing “▲” or “▼” , and then press “OK” to restore factory settings.



11.1.5. Mute printing

Set mute mode to realize low speed printing with low noise. When mute mode is “on”, printing will be in a low speed. This mode is “off” by default.

1. Press "Menu" to enter the menu setting interface.
2. Press "▲" or "▼" to select "System Setting" and then press "OK".
3. Select “Mute Printing” by pressing “▲” or “▼” , and then press “OK” to enable the mute printing mode.

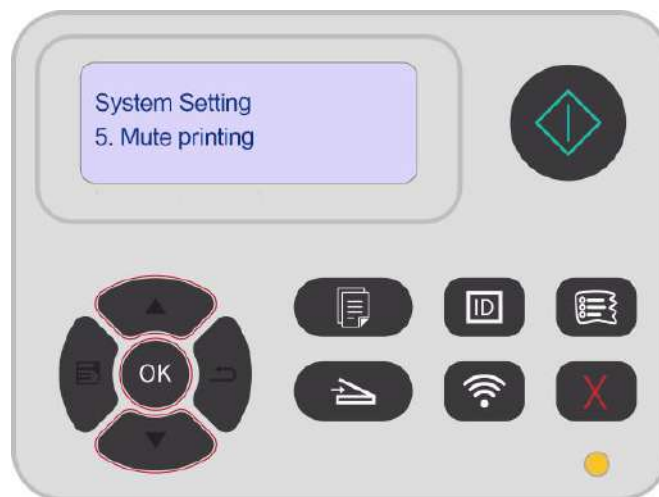

11.1.6. Auto shut-off setting

“Auto shut-off setting” to set off condition and off delay of printer.

1. Press "Menu" to enter the menu setting interface.
2. Press "▲" or "▼" to select "System Setting" and then press "OK".
3. Press direction key “▲” or “▼” to select options of “Auto off set” , press “OK” to set off condition and off delay.



 **Note:** Set auto off condition:

- Shutdown under no-port state (default configuration. : no port is connected, Wi-Fi function deactivated, printer is under standby or sleep mode.
 - Shutdown under idle state: the printer is under standby or sleep mode.
 - If auto off condition is satisfied, printer will be off at the preset time.
 - After printer is off, power consumption is 0.5W or lower.
 - Individual countries (or regions) do not support auto off setting.
-

11.1.7. Panel energy saving settings

Set the panel energy-saving function on the control panel to save the power consumption of the printer.

 **Note:** • When the panel energy saving mode is “Enabled”, the printer is in the sleep mode, and printing or scanning is started from PC, the LCD screen of the printer will not wake up.

1. Press "Menu" to enter the menu setting interface.
2. Press "▲" or "▼" to select "System Setting" and then press "OK".
3. Select “PNL Eco Settings” by pressing “▲” or “▼”, and then press “OK” to enable or disable the panel energy saving mode.

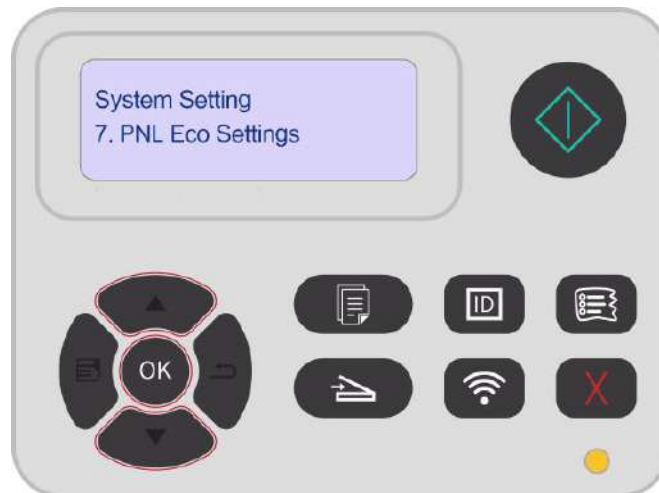

11.2. Print Settings

11.2.1. Print Density

You can set the toner density to make the print effect pale or dark.

1. Press "Menu" to enter the menu setting interface.
2. Select "Print Settings" by pressing "▲" or "▼", and then press "OK".
3. Press the direction keys "▲" or "▼" to select the "Print Density" option, and press the "OK" key to adjust the print density.



11.2.2. Color Calibration

When the environment where your printer is used changes greatly, the printer may automatically perform color calibration for better printing results. In case of ghosting or large color difference, you can manually calibrate colors as follows:

1. Press "Menu" to enter the menu setting interface.
2. Select "Print Settings" by pressing "▲" or "▼", and then press "OK".
3. Select "Color Calibration" by pressing "▲" or "▼", and then press "OK" to set "Full Calibration" and "Position Calibration".

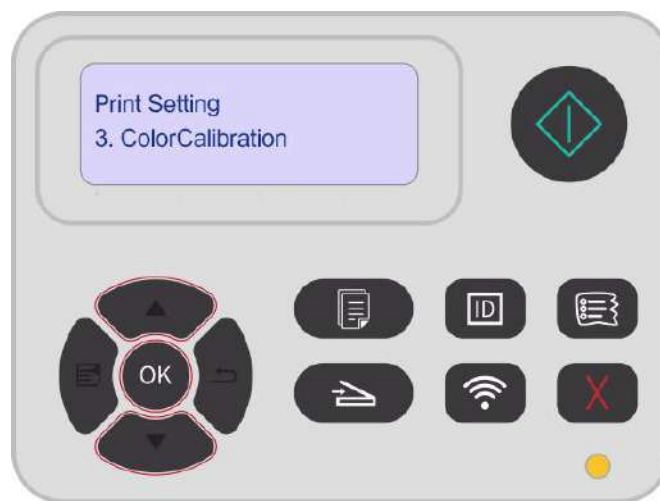



- Note:**
- When your printer performs a certain amount of print jobs, it will automatically perform color calibration.
 - When you replace the laser toner cartridge with a new one, the printer will automatically perform color calibration.
-

11.2.3. Transfer Print Settings

If the printed image is mottled or blotchy-looking, you can manually adjust the parameters under Transfer Print Settings in the following way:

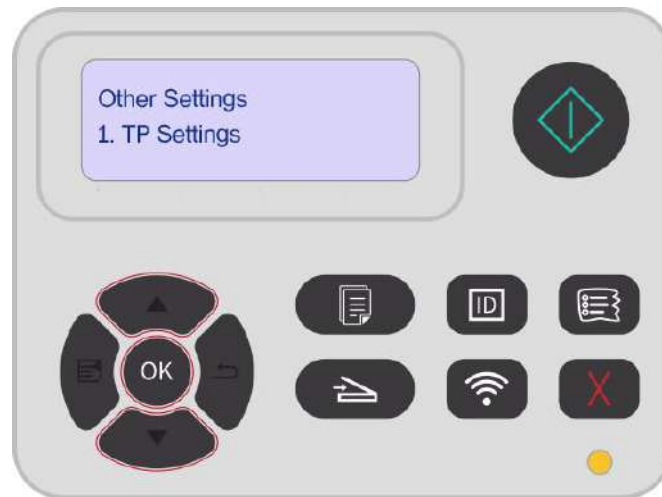
1. Press "Menu" to enter the menu setting interface.
2. Select "Print Settings" by pressing "▲" or "▼", and then press "OK".
3. Press "▲" or "▼", select "Other Settings", and press "OK" to set the parameters under "TP Settings".



 **Note:** • You can also set the transfer parameters through the printer setup interface on computer. Please see [Section 7.2.5](#).

11.3. Network Settings

You can check or set network through Network set

1. Press "Menu" to enter the menu setting interface.
2. Press direction key "▲" or "▼" and select " Network Set" option.
3. Press "OK" key to set "Network set", "wireless network setting" and "Wi-Fi Direct".



11.4. Network Information

You can check the network status through Network Information.

1. Press "Menu" to enter the menu setting interface.
2. Select "Network Information" by pressing "▲" or "▼".
3. Press "OK" to view the corresponding "Network Info", "Wireless Network Information" and "Wi-Fi Connection Information".

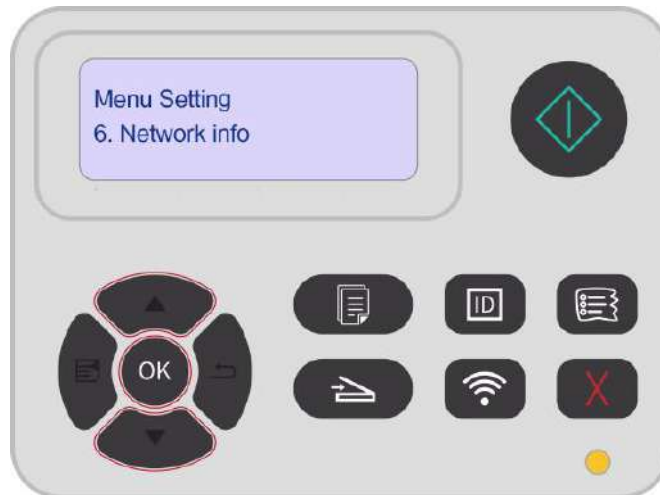

11.5. Online upgrade

1. Switch on the printer and then connect it to network.
2. Press "Menu" to enter the menu setting interface.
3. Select "Online upgrade" by pressing "▲" or "▼".
4. Press "OK" and proceed according to prompts. Restart the printer after upgrading.

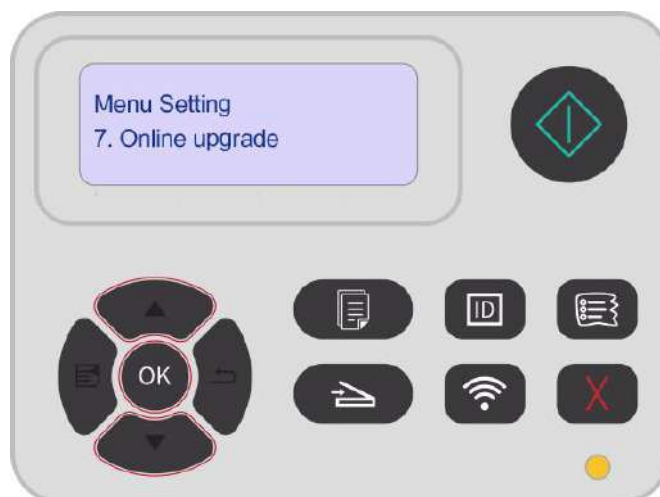

 **Note:** • Perform upgrading according to the prompts and restart the printer. If the firmware download fails, restart the printer and then perform operation again.

11.6. Information report

You can print information report by operating control panel. These pages can help you to learn about product information, and diagnose and solve product failures.

1. Press "Menu" to enter the menu setting interface.
2. Press "▲" or "▼" to select "Info.report".
3. Press "OK" key to enter information report print. You can print product report according to needs.

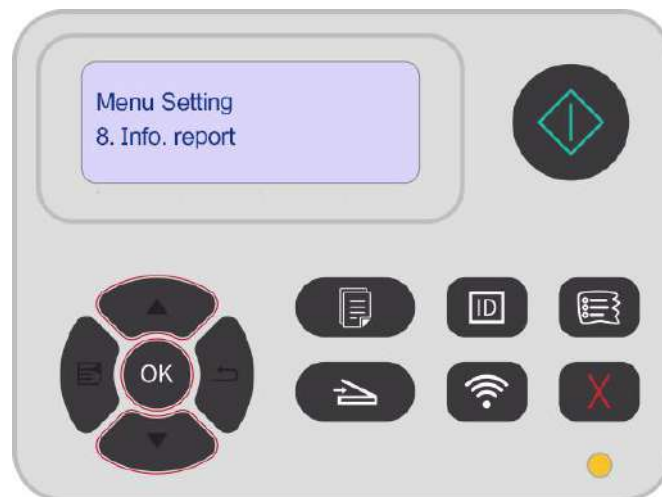

Printable product reports include Demo pages, information pages, log information pages, menu structure pages, quality test pages, network configuration, email address, group mails, FTP address, Wi-Fi hotspot, etc.



Note: • The product report above is the most complete version, and may be different from the product report of model that you actually use.

11.7. Consumable information

You can view the consumable information via the control panel of the printer.

1. Press "Menu" to enter the menu setting interface.
2. Select "Consumable Info." by pressing "▲" or "▼".
3. Press "OK" to view the remaining amount of toner, status of waste toner bottle and other information.

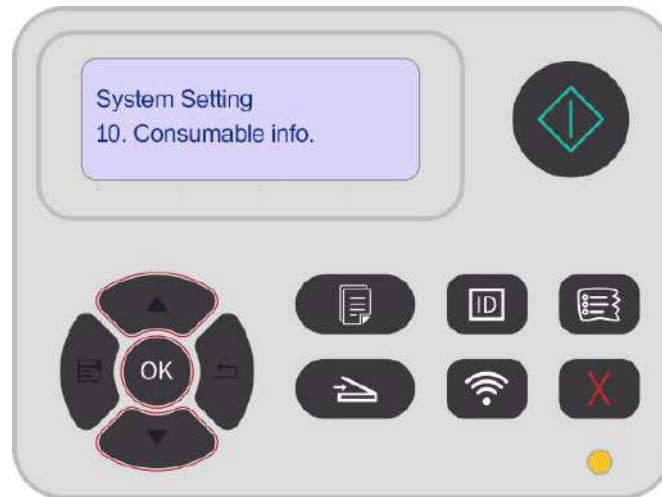



12. Routine Maintenance

 **Note:** • Printer appearance may differ because of different models and functions, so the schematic diagram is only for your reference.

12.1. Cleaning the Printer

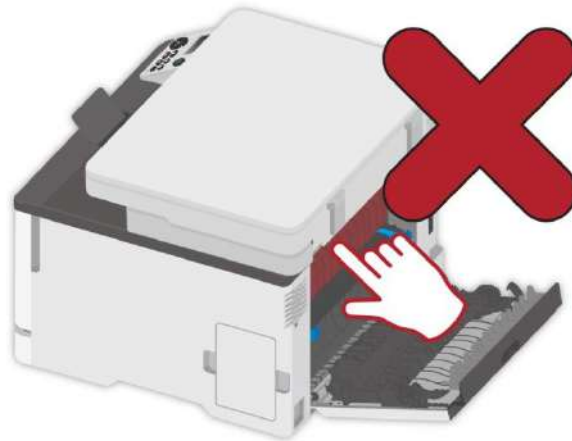
 : Some parts of the printer are still in high temperature within a short time after use. To prevent burns, please don't directly touch places labeled with high temperature warning in contact with internal components after opening the printer's front or rear.



 **Note:** • Disconnect the printer before cleaning.

- Please use mild detergents.
- Use caution when using the printer display to prevent pressing or damaging the touch display. Please use a soft dry cloth or dip in a neutral detergent or ethanol to clean the display surface. Do not use any organic solvents, acidic or alkaline solutions.

12.1.1. Please use mild detergents.



: To avoid the risk of electrical shock when cleaning the exterior of the printer, unplug the power cord from the electrical outlet and disconnect all cables from the printer before proceeding.



Note:• Please perform this job every few months.

- Damage to the printer caused by improper handling is not covered by the printer warranty.

1. Turn off the printer, and then unplug the power cord from the electrical outlet.

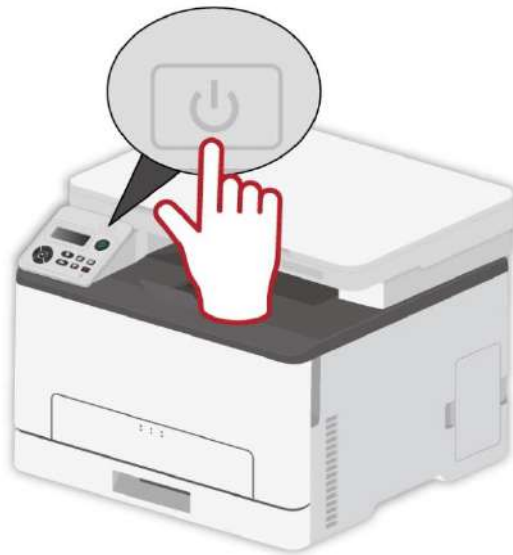

2. Remove the paper from the standard exit and feed tray.

3. Remove any dust, lint, and pieces of paper around the printer using a soft brush or vacuum.

4. Wipe the outside of the printer with a damp, soft, lint-free cloth.





Note: • Do not use household cleaners or detergents, as they may damage the surface of the printer.

- Make sure that all areas of the printer are dry after cleaning.
-

5. Connect the power cord to the electrical outlet, and then turn on the printer.



: To avoid the risk of fire or electrical shock, connect the power cord to an appropriately rated and properly grounded electrical outlet that is near the product and easily accessible.

12.2. Replacing parts and consumables

1. Use and maintenance of toner cartridge.

Please use the original toner cartridge for better printing quality.

Please pay attention to the following items while using the toner cartridge:

- Please keep the toner cartridge in a dry and dark place.
- Do not refill the toner cartridge without permission; otherwise, the damages caused will not be included in the scope of warranty of the printer.
- Please place the toner cartridge in cool and dry places.
- Please do not place the toner cartridge near ignition sources, as the toner inside it is inflammable and may cause fire.
- Please pay attention to toner leakage while it is taking out or disassembled. In case of toner leakage, skin contact with toner or spattering into eyes or mouth, please wash it with clear water immediately, or see a doctor if feeling unwell.
- When placing the cartridge, please stay away from children may contact area.

2. Service life of toner cartridge

- The service life of toner cartridge is depending on the toner quantity needed by printing.
- When a prompt that "The Toner Cartridge life Expired" appears on the display, it indicates its service life expires. So please replace it.

12.2.1. Replacing the toner cartridge

 **Note:** • If the tray is unfolded, remove it before replacing the toner cartridge.

1. Open the front cover, and then push it down hard.

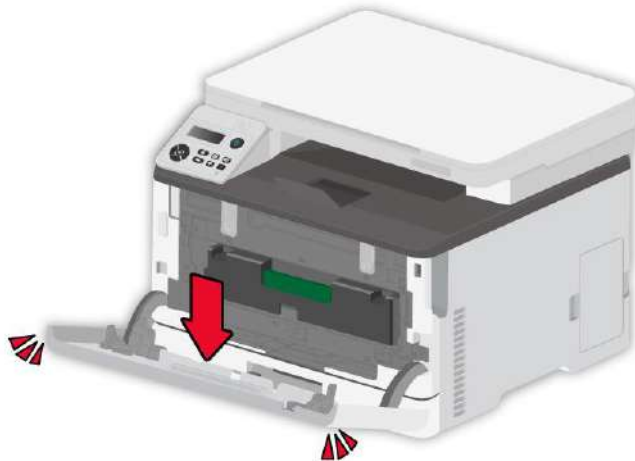
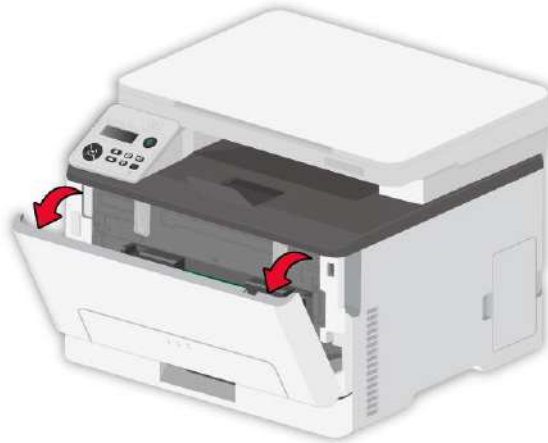

2. Pull out the toner cartridge tray.

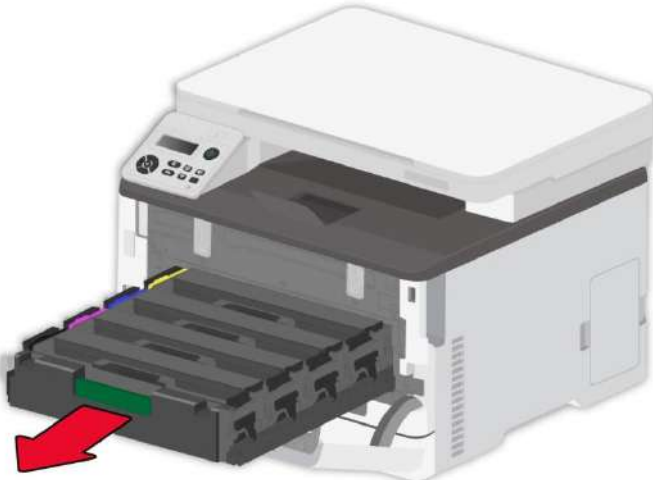

3. Remove the used toner cartridge.

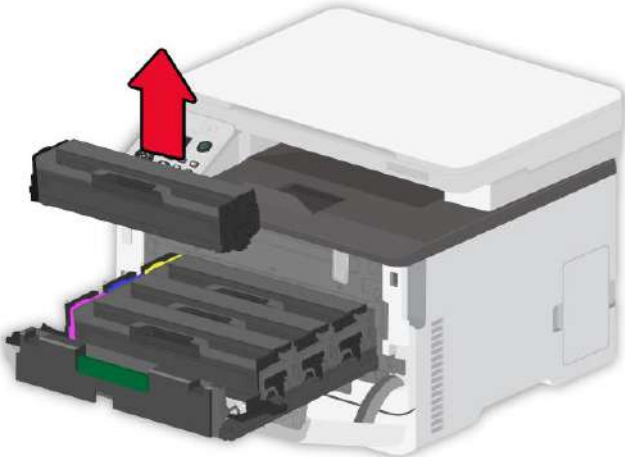
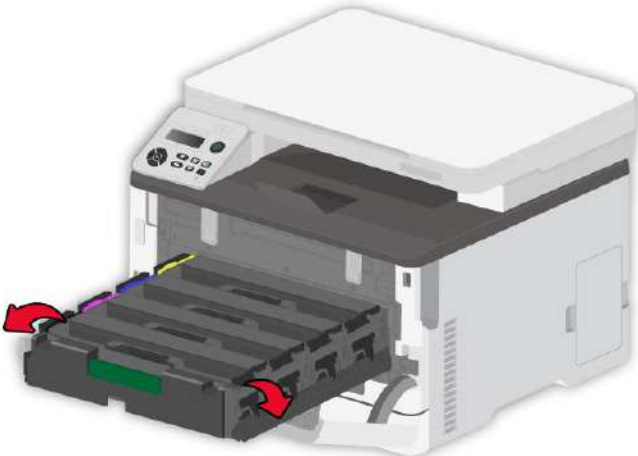

4. Unpack the new toner cartridge.

-
-  **Note:** • Do not expose the bottom of the toner cartridge to direct light. Prolonged exposure to light may cause print quality problems.
- Do not touch the bottom of the toner cartridge. Otherwise it will affect the quality of future print jobs.
-



5. Insert a new toner cartridge.

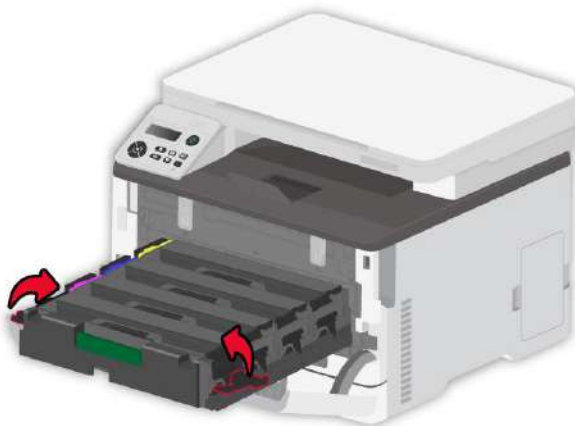
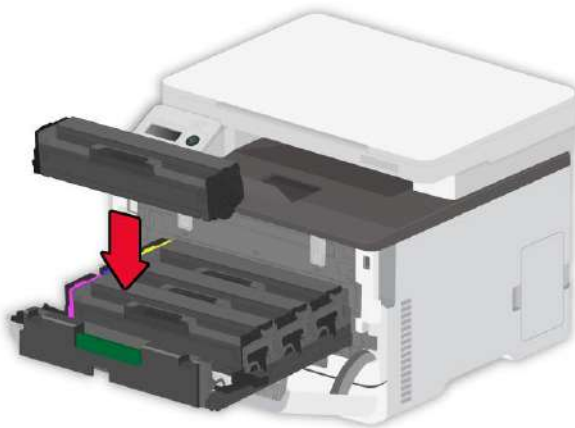

6. Insert the toner cartridge tray, and then close the cover.

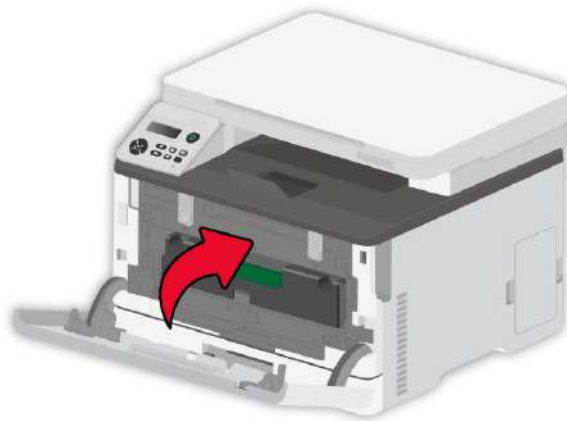
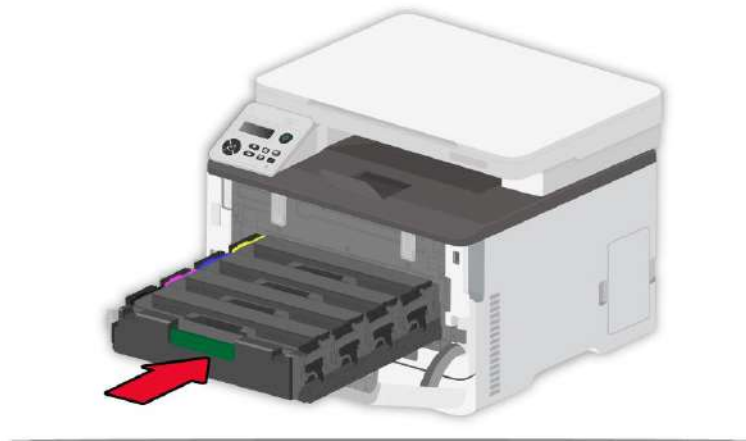

12.2.2. Replacing the waste toner bottle

1. Remove the used waste toner bottle.



 **Note:** • To avoid toner leakage, keep the waste toner bottle upright.

2. Unpack the new waste toner bottle.
3. Insert a new waste toner bottle.



12.2.3 Replace the tray

1. Remove the used tray.



2. Unpack the new tray.

3. Insert a new tray.



12.3. Move the printer

12.3.1. Move the printer to another location



: To avoid the risk of electrical shock, do not place or use this product near water or wet locations.



: If the printer weighs more than 18 kg, then it requires two or more trained personnel to lift it safely.



: To avoid the risk of fire or electrical shock, use only the power cord provided with this product or the manufacturer's authorized replacement.



: When moving the printer, follow these guidelines to avoid personal injury or printer damage:

- Make sure that all covers and trays are closed.
- Turn off the printer, and then unplug the power cord from the electrical outlet.
- Disconnect all cords and cables from the printer.
- If the printer has casters on its base, then carefully move it to the new location. Use caution when passing over thresholds and breaks in flooring.
- Always use the handholds on the printer to lift it.
- Any cart used to move the printer must have a surface able to support the full footprint of the printer.

- Keep the printer upright.
- Avoid violent vibrations when moving.
- Make sure that your fingers are not under the printer when you set it down.
- Make sure that there is adequate clearance around the printer.



Note: • Damage to the printer caused by improper handling is not covered by the printer warranty.

12.3.2. Transporting the printer

When transporting the printer, use the original packaging.

11.1.7. Panel energy saving settings

Set the panel energy-saving function on the control panel to save the power consumption of the printer.

 **Note:** • When the panel energy saving mode is “Enabled”, the printer is in the sleep mode, and printing or scanning is started from PC, the LCD screen of the printer will not wake up.

1. Press "Menu" to enter the menu setting interface.
2. Press "▲" or "▼" to select "System Setting" and then press "OK".
3. Select “PNL Eco Settings” by pressing “▲” or “▼” , and then press “OK” to enable or disable the panel energy saving mode.

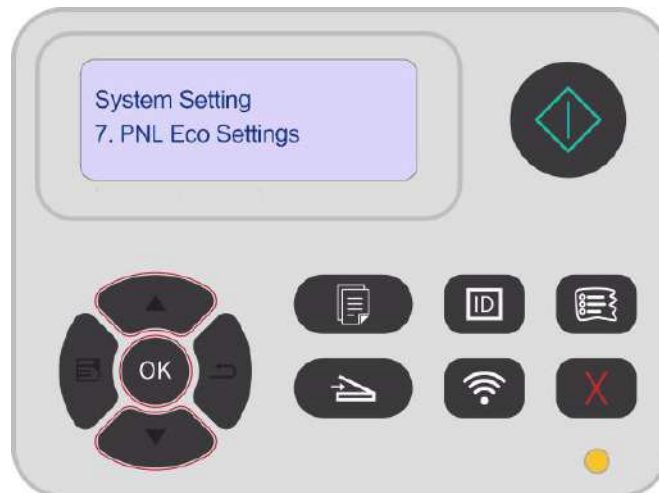

11.2. Print Settings

11.2.1. Print Density

You can set the toner density to make the print effect pale or dark.

1. Press "Menu" to enter the menu setting interface.
2. Select "Print Settings" by pressing "▲" or "▼" , and then press "OK" .
3. Press the direction keys "▲" or "▼" to select the "Print Density" option, and press the "OK" key to adjust the print density.



11.2.2. Color Calibration

When the environment where your printer is used changes greatly, the printer may automatically perform color calibration for better printing results. In case of ghosting or large color difference, you can manually calibrate colors as follows:

1. Press "Menu" to enter the menu setting interface.
2. Select "Print Settings" by pressing "▲" or "▼", and then press "OK".
3. Select "Color Calibration" by pressing "▲" or "▼", and then press "OK" to set "Full Calibration" and "Position Calibration".

 **Note:** • When your printer performs a certain amount of print jobs, it will automatically perform color calibration.

- When you replace the laser toner cartridge with a new one, the printer will automatically perform color calibration.

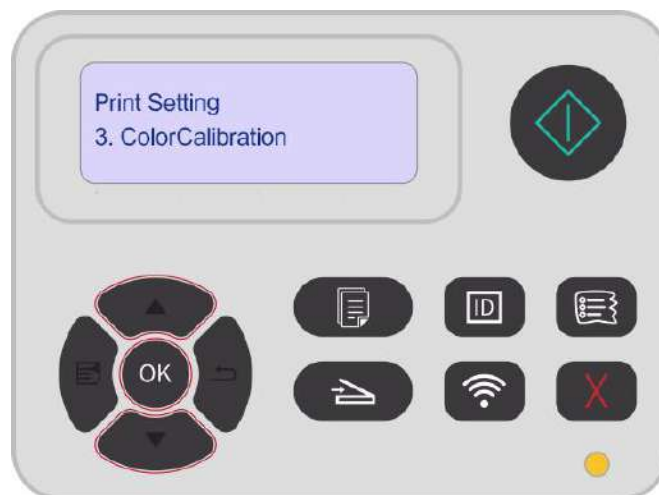

11.2.3. Transfer Print Settings

If the printed image is mottled or blotchy-looking, you can manually adjust the parameters under Transfer Print Settings in the following way:

1. Press "Menu" to enter the menu setting interface.
2. Select "Print Settings" by pressing "▲" or "▼", and then press "OK".
3. Press "▲" or "▼", select "Other Settings", and press "OK" to set the parameters under "TP Settings".

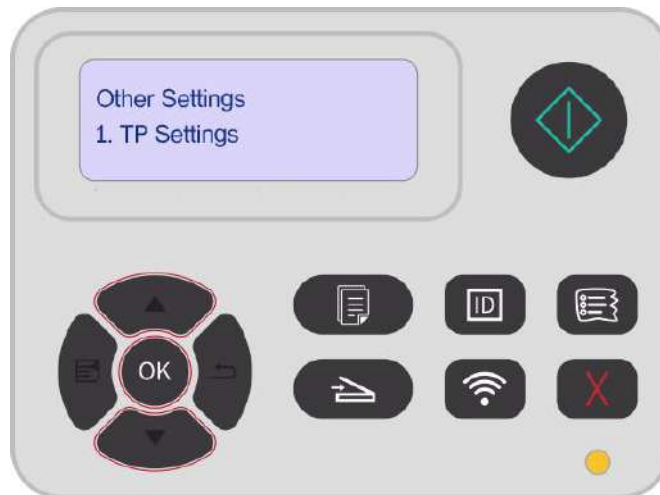

 **Note:** • You can also set the transfer parameters through the printer setup interface on computer. Please see [Section 7.2.5](#).

11.3. Network Settings

You can check or set network through Network set

1. Press "Menu" to enter the menu setting interface.
2. Press direction key “▲” or “▼” and select “ Network Set” option.
3. Press “OK” key to set “Network set”, “wireless network setting” and “Wi-Fi Direct”.

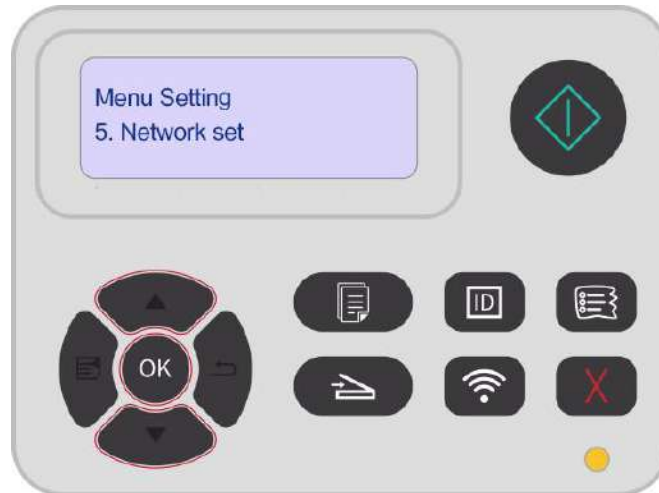

11.4. Network Information

You can check the network status through Network Information.

1. Press "Menu" to enter the menu setting interface.
2. Select “Network Information” by pressing “▲” or “▼” .
3. Press “OK” to view the corresponding “Network Info”, “Wireless Network Information” and “Wi-Fi Connection Information”.



11.5. Online upgrade

1. Switch on the printer and then connect it to network.
2. Press "Menu" to enter the menu setting interface.
3. Select "Online upgrade" by pressing "▲" or "▼" .
4. Press "OK" and proceed according to prompts. Restart the printer after upgrading.

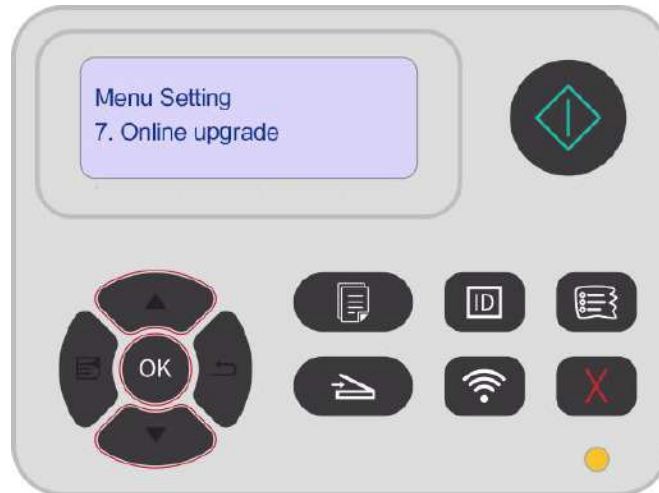

 **Note:** • Perform upgrading according to the prompts and restart the printer. If the firmware download fails, restart the printer and then perform operation again.

11.6. Information report

You can print information report by operating control panel. These pages can help you to learn about product information, and diagnose and solve product failures.

1. Press "Menu" to enter the menu setting interface.
2. Press "▲" or "▼" to select "Info.report".
3. Press "OK" key to enter information report print. You can print product report according to needs.

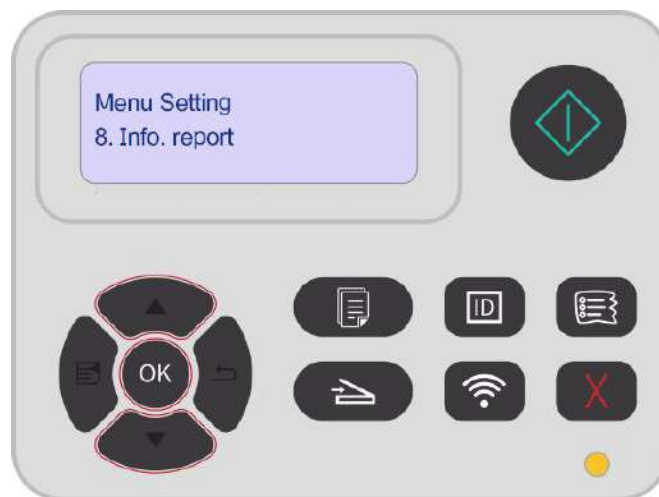

Printable product reports include Demo pages, information pages, log information pages, menu structure pages, quality test pages, network configuration, email address, group mails, FTP address, Wi-Fi hotspot, etc.

 **Note:** • The product report above is the most complete version, and may be different from the product report of model that you actually use.

11.7. Consumable information

You can view the consumable information via the control panel of the printer.

1. Press "Menu" to enter the menu setting interface.
2. Select "Consumable Info." by pressing "▲" or "▼".
3. Press "OK" to view the remaining amount of toner, status of waste toner bottle and other information.

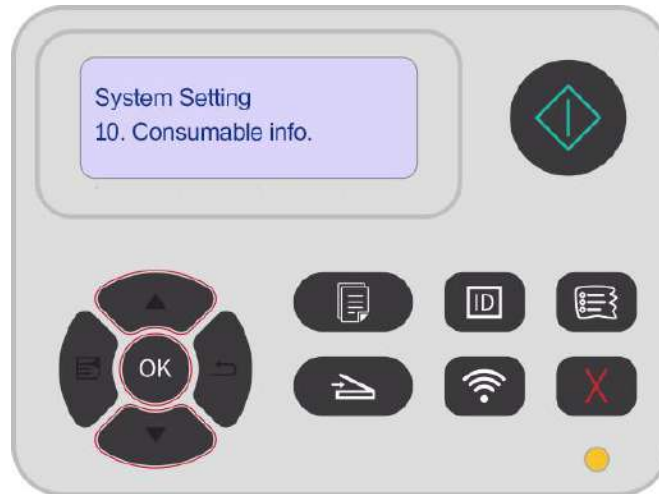

13. Troubleshooting

Please read this section carefully. It may help you to solve common problems encountered during the printing process. If the problems persist, please contact Pantum Aftersales Service Centre.

Prior to handling common problems, first check that:

- The power cord is connected correctly and the printer is powered on.
- All of the protective parts are removed.
- The toner cartridge is installed correctly.
- The paper is correctly loaded into the tray.
- The interface cable between the printer and the computer is connected correctly.
- The correct printer driver has been selected and installed properly.
- The computer port is properly configured and is connected to the correct printer port.

13.1. Avoiding jams

13.1.1. Correct loading of paper

- Make sure that the paper lies flat in the tray.

Correct loading of paper



Incorrect loading of paper

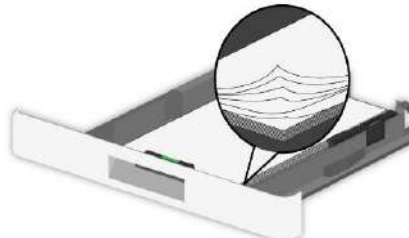

- Do not load or remove a tray while the printer is printing.
- Do not load too much paper. Make sure that the stack height is below the maximum paper fill indicator.
- Do not slide paper into the tray. Load paper as shown in the figure.



- Make sure that the paper guides are positioned correctly and are not pressing tightly against the paper or envelopes.
- After loading the paper, push the tray into the printer.

13.1.2. Use recommended paper

- Use only recommended paper or special media.
- Do not load paper that is wrinkled, creased, damp, bent, or curled.
- Flex, fan out and align the paper edges before loading.

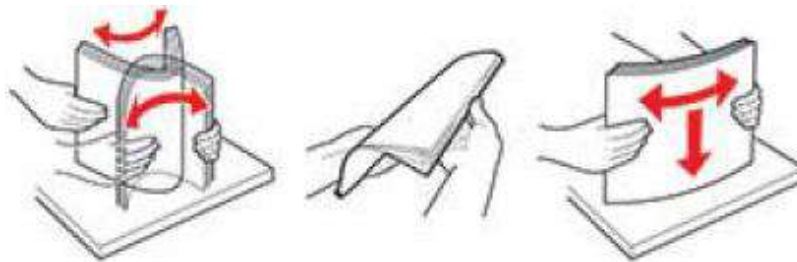

- Do not use paper that has been cut or trimmed by hand.
- Do not mix paper sizes, weights, or types in the same tray
- Make sure that the paper size and type are set correctly on the computer or printer control panel.
- Store paper according to manufacturer recommendations.

13.2. Locate jammed paper

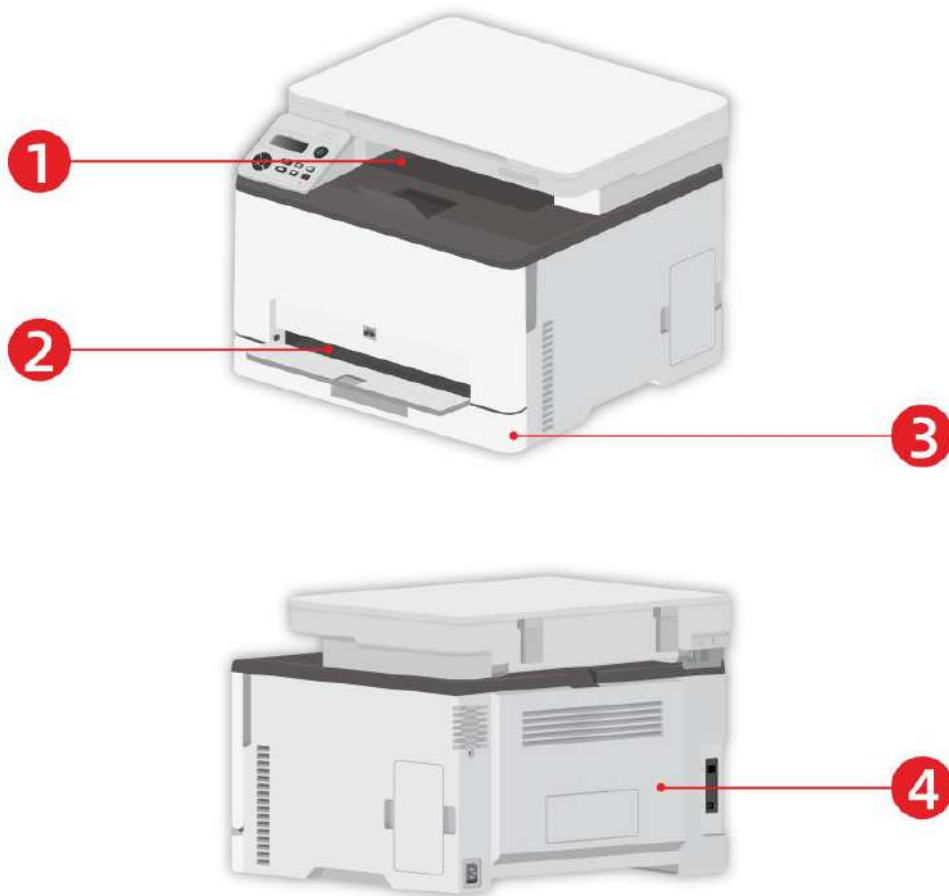

| No. | Paper jam locations |
|-----|-----------------------|
| 1 | Standard exit |
| 2 | Manual feed tray |
| 3 | Automatic Feeder Tray |
| 4 | Rear cover |

13.3. Cleaning Jammed Paper

13.3.1. Paper jam in the automatic tray

1. Remove the tray.



2. Remove the jammed paper.

 **Note:** • Make sure that all paper fragments are removed.



3. Insert the tray.

4. Open the rear cover.



: The inside of the printer might be hot. To reduce the risk of injury by a hot component, allow the surface to cool before touching it.

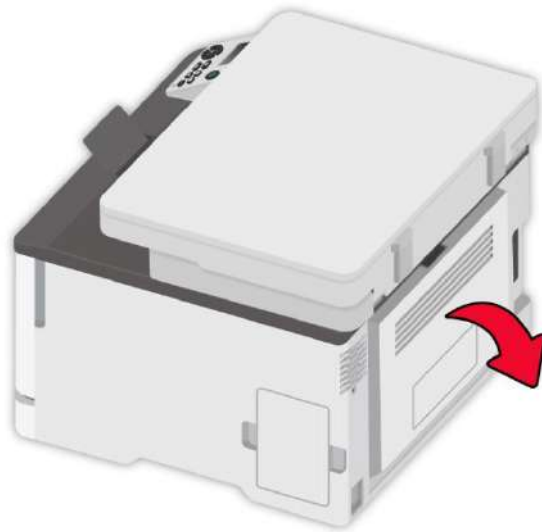

5. Remove the jammed paper.



Note: • Make sure that all paper fragments are removed.

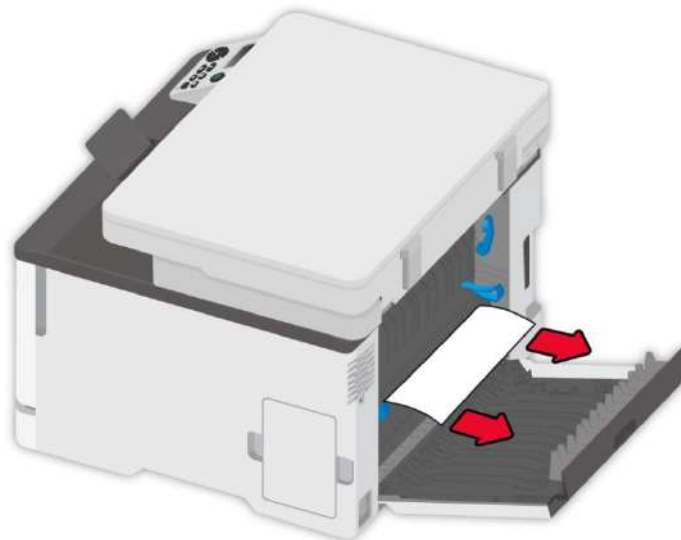

6. Close the cover.

13.3.2. Paper jam in the manual tray

1. Open the front cover, and then push it down hard.

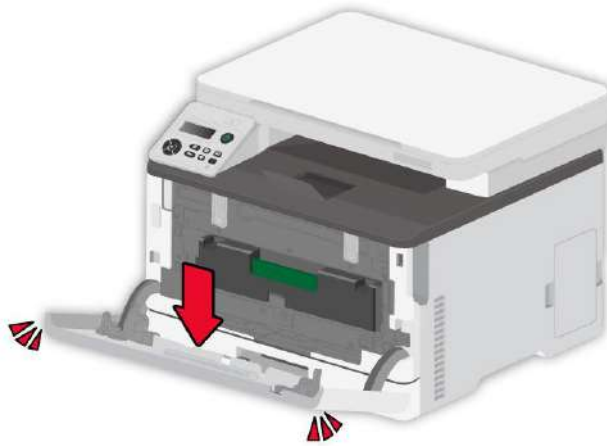

2. Remove the jammed paper.

 **Note:** • Make sure that all paper fragments are removed.

3. Close the front cover.

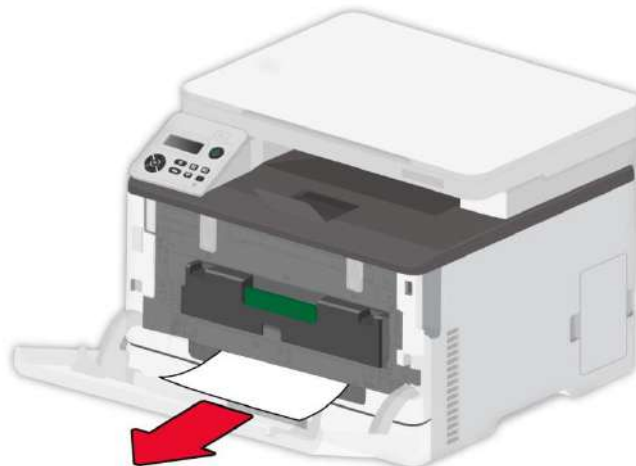

 **Note:** • If the problem still cannot be solved, please contact the customer services center.

13.3.3. Paper jam in the rear cover

1. Open the rear cover.



: The inside of the printer might be hot. To reduce the risk of injury by a hot component, allow the surface to cool before touching it.

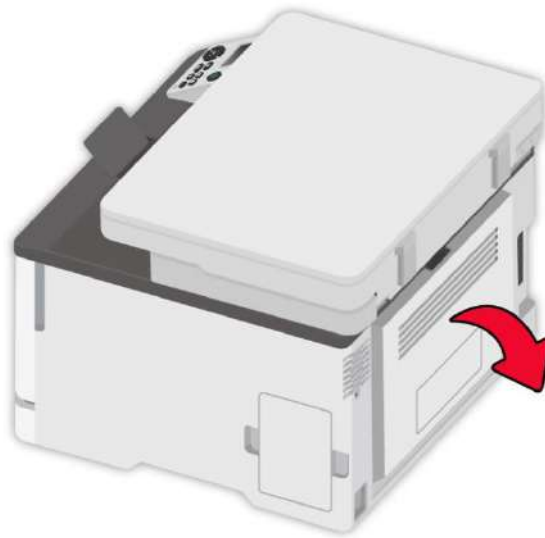

2. Remove the jammed paper.



Note: • Make sure that all paper fragments are removed.

- Fuser area

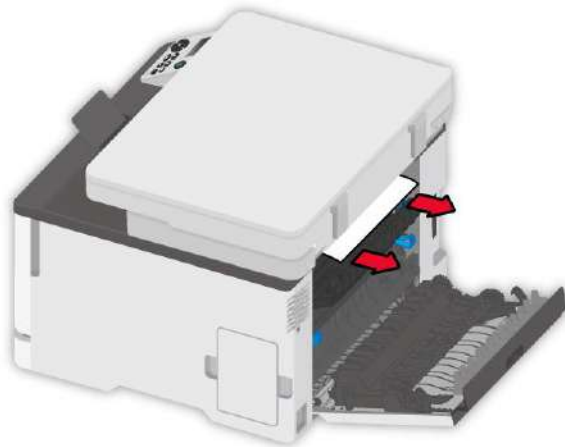
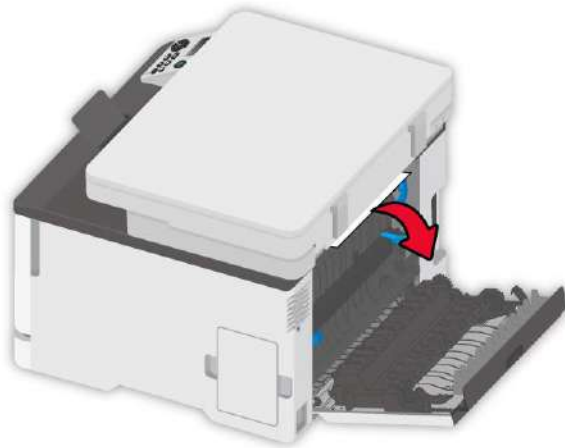

- Below the fuser area

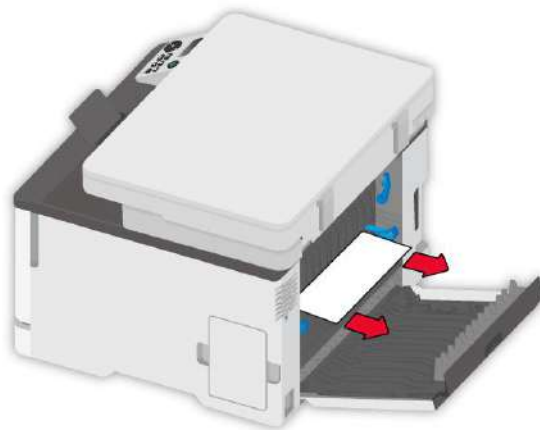
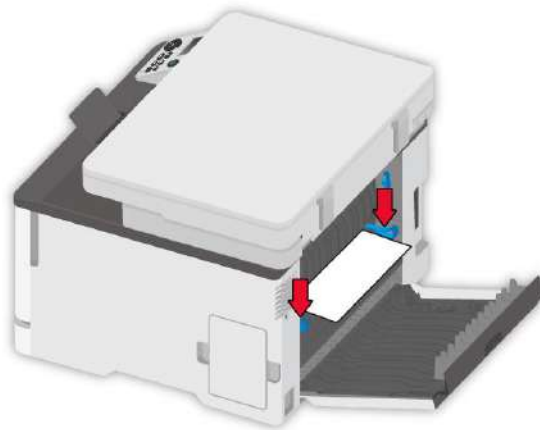

- Duplex unit

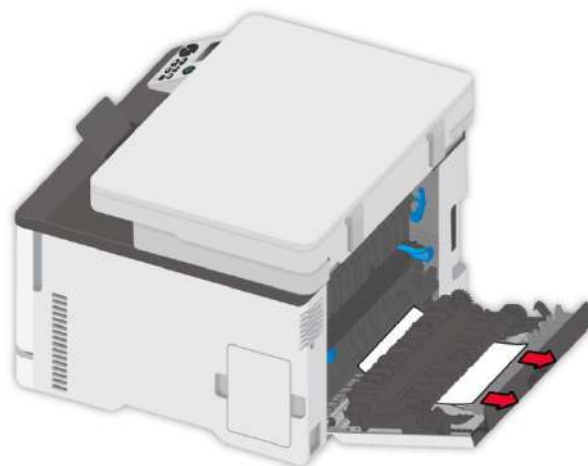

3. Close the cover.

13.4. Software Failure

| Problem | Solution |
|---|--|
| The printer icon is not displayed in the “Device and Printer” folder. | Reinstall the printer driver. |
| | Ensure that the USB interface cable and the power cord are properly connected. |
| The printer is in Ready mode but it will not perform any print job. | If the failure still exists after restarting the printer, please reinstall the printer driver. |
| | Make sure the network cable of USB cable is connected correctly. |
| Failed to install the driver | Check whether the print spooler service is enabled. |
| | Check the power supply and the connection of the printer. |
| The driver cannot be used if the IP address of the printer has been changed | Modify the port IP address of the printer driver. |
| | If the above method does not work, please reinstall the printer driver. |
| | It is recommended that a fixed IP address should be set to the network printer. |
| | In the DHCP network, it is recommended to bind the IP address with the MAC address of the printer. |

13.5. Error Message

| Error Message | Cause | Measure |
|------------------------------------|--|---|
| No toner cartridge is installed. | The toner cartridge is not installed correctly or the toner cartridge is damaged. | Install the toner cartridge correctly or replace it with a new one. |
| Toner Low | Any toner cartridge is running low on toner. | Please prepare a corresponding new toner cartridge. |
| Cartridge Err | The printer does not support the toner cartridge. | Please replace the toner cartridge supported by the printer. |
| Toner life end | Toner has been used up. | Replace the toner cartridge. |
| Feed Failure | Paper is not installed correctly. Paper is beyond the specification. | Please install the paper correctly. |
| Paper settings mismatched | Paper size or paper type at drive end mismatches setting on printer's control panel. | Please change paper size or paper type at printer end. |
| Paper jam in printer | Paper is not installed correctly. | Please install the paper correctly. |
| Waste toner bottle is nearly full | Waste toner bottle works under capacity. | Please prepare a new waste toner bottle. |
| The waste toner bottle is full. | Waste toner bottle is full. | Please replace the waste toner bottle. |
| No waste toner bottle is detected. | The waste toner bottle is not installed correctly. | Please remove and reinstall the waste toner bottle. |
| Scanner is Busy | With other scan jobs. | Please cancel the current scan job or wait for the completion of other scan jobs. |
| Scan failed | Scanner internal failure. | Please contact Pantum Customer Service. |



Note: • If the problem still cannot be solved, please contact the customer services center.

13.6. Common Troubleshooting

13.6.1. Common Problems

| Trouble Type | Problem | Cause | Solution |
|---------------------------|---------------------------|---|--|
| Problems in printing | Poor print quality | <ul style="list-style-type: none"> See the image defect in Section 13.6.2. | <ul style="list-style-type: none"> See the image defect in Section 13.6.2. |
| Problems in copying | Failed to copy | <ul style="list-style-type: none"> The scanner is damaged. | <ul style="list-style-type: none"> Please contact Pantum Customer Service. |
| | Copy Image Abnormal | <ul style="list-style-type: none"> The scanner is dirty or defective. The toner cartridge is dirty or damaged. | <ul style="list-style-type: none"> Clean the scanner. It is suggested to replace the original toner cartridge. |
| Problems with the Printer | The printer does not work | <ul style="list-style-type: none"> Power cord of the device is not properly connected. The cable between the computer and the printer is not connected properly. Error in specifying the print port. | <ul style="list-style-type: none"> Ensure proper connection of the power cord. Disconnect and then reconnect the printer cable. Check the Windows printer settings to ensure that the print job has been sent to the correct port. If the computer has more than one port, make sure that the printer is connected to the correct port. |
| | | <ul style="list-style-type: none"> The printer is offline and User Guide of Printer is checked. The printer has not recovered from an internal error, such as a paper jam, paper empty, etc. Driver program of printer is not installed correctly. | <ul style="list-style-type: none"> Make sure that the printer is in the normal online status. Please eliminate errors so that the printer can recover to its normal state. Unload and reinstall the driver program of printer. |
| Problems in scanning | Scanning error | <ul style="list-style-type: none"> Data cable of the device is not properly connected. The scan driver is installed incorrectly. The LCD screen prompts error messages. | <ul style="list-style-type: none"> Ensure proper connection of the data cable. Reinstall the scan driver. |



| | | | |
|------------------------------|----------------------|--|---|
| | Paper feed failure | <ul style="list-style-type: none"> • The print media has been loaded incorrectly. • The print media is out of the supported media range. • The feed roller is dirty. • Too many papers in paper tray. | <ul style="list-style-type: none"> • Please install printing medium correctly; please print with manual feed tray if special printing medium is used to print. • Please use the print media within the specification range. • Clean the feed roller. • Remove excess paper from the tray. For printing on special print media, use the manual tray. |
| Problems with Paper Handling | Paper Jam | <ul style="list-style-type: none"> • Too many papers in paper tray. • The print media is out of the supported media range. • There is foreign matter in the paper path. • The feed roller is dirty. • Internal parts failure. | <ul style="list-style-type: none"> • Remove excess paper from the tray. For printing on special print media, use the manual tray. • Make sure to use the paper that meets specifications. For printing on special print media, use the manual tray. • Clean the paper path. • Clean the feed roller. |
| | Print multipage feed | <ul style="list-style-type: none"> • Excessive static electricity on the print media. • The print media is damp and is sticking together. • Internal parts failure. | <ul style="list-style-type: none"> • Separate the print media to eliminate some static electricity. It is suggested that you use the recommended print media. • Separate the print media or use better quality and dry print media. |

 **Note:** • If the problem still cannot be solved, please contact the customer services center.

13.6.2. Image Defects



Note: • Before the problem is solved, please print the “Print Quality Test Page”. For the way to print the quality test page, please refer to [Section 11.6](#).

| Problem | Cause | Solution |
|---|---|--|
|  Blank or white pages | <ul style="list-style-type: none"> • Toner cartridge is not installed properly. | <ul style="list-style-type: none"> • Pull out the toner cartridge tray, remove the toner cartridge, then insert the toner cartridge, and insert the toner cartridge tray. |
|  Dark print | <ul style="list-style-type: none"> • A higher density is set when printing. • The print media does not meet the usage specification. For example, the print media is textured, damp, or too rough. • The paper used has been stored in the air for a prolonged time. | <ul style="list-style-type: none"> • Adjust the toner density from “Printing Preferences” according to your operating system, or by selecting “Print Density” on the control panel, see Section 11.2.1 for details. • Please correctly use the medium conforming to the specifications. See Section 2. • Keep the paper in its original wrapper before use. • Perform the “Fully Calibrated” setting, please refer to Section 11.2.2 for the setting mode. |
|  Ghost images | <ul style="list-style-type: none"> • The tray fails to load the media properly. • Toner cartridge is not installed properly. | <ul style="list-style-type: none"> • Load correct paper. Please refer to Section 2.4 for the way to load paper correctly. • Pull out the toner cartridge tray, remove the toner cartridge, then insert the toner cartridge, and insert the toner cartridge tray. • Perform the “Margin Calibrated” or “Fully Calibrated” setting, please refer to Section 11.2.2 for the setting mode. |

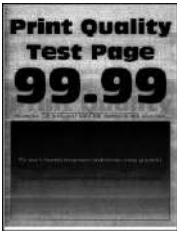

Gray or colored background

- Toner cartridge is not installed properly.
- The paper path is dirty.
- Scanning exposure.
- If a gray or colored background appears during copying or scanning, the glass platen may be dirty.
- Pull out the toner cartridge tray, remove the toner cartridge, then insert the toner cartridge, and insert the toner cartridge tray.
- Clean the paper path.
- Please close the cover on the manuscript, and then carry out copying and scanning.
- Clean the platen glass.



Incorrect margins

- The tray fails to load the media properly.
- The print margin is set incorrectly.
- Load correct paper. Please refer to [Section 2.4](#) for the way to load paper correctly.
- Please set the correct print margin.
- Perform the “Margin Calibrated” or “Fully Calibrated” setting, please refer to [Section 11.2.2](#) for the setting mode.



Light print

- A lower density is set when printing.
- The print media does not meet the usage specification. For example, the print media is textured, damp, or too rough.
- The resolution in the print program is set too low, and the density is set too low.
- The paper used has been stored in the air for a prolonged time.
- Toner cartridge is not installed properly.
- Toner Save set is checked.
- Please correctly use the medium conforming to the specifications. See [Section 2](#).
- Adjust the toner density from “Printing Preferences” according to your operating system, or by selecting “Print Density” on the control panel, see [Section 11.2.1](#) for details.
- Keep the paper in its original wrapper before use.
- Pull out the toner cartridge tray, remove the toner cartridge, then insert the toner cartridge, and insert the toner cartridge tray.
- Please check whether the Toner Save mode is enabled.
- Perform the “Fully Calibrated” setting, please refer to [Section 11.2.2](#) for the setting mode.



Missing color

- Toner cartridge is not installed properly.
- The developing unit of the missing color is not installed properly.
- Pull out the toner cartridge tray, remove the toner cartridge, then insert the toner cartridge, and insert the toner cartridge tray.
- Please remove the developing unit of the missing color and re-insert it. .



Mottles and spots

- The toner cartridge is dirty or leaks toner.
- The print media does not meet the usage specification. For example, the print media is textured, damp, or too rough.
- The paper used has been stored in the air for a prolonged time.
- Toner cartridge is not installed properly.
- Incorrect transfer print settings.
- The paper path is dirty.
- If toner spots appear when copying and scanning, the platen glass may be dirty.
- The scanner is dirty or damaged.
- Please contact the customer service center.
- Please correctly use the medium conforming to the specifications. See [Section 2](#).
- Keep the paper in its original wrapper before use.
- Pull out the toner cartridge tray, remove the toner cartridge, then insert the toner cartridge, and insert the toner cartridge tray.
- Please readjust transfer print parameters. For specific steps, please see [Section 7.2.5](#) or [Section 11.2.3](#).
- Clean the paper path.
- Clean the platen glass.



Paper crooked

- The tray fails to load the media properly.
- The paper used has been stored in the air for a prolonged time.
- Load correct paper. Please refer to [Section 2.4](#) for the way to load paper correctly.
- Keep the paper in its original wrapper before use.



Print is crooked or skewed

- The tray fails to load the media properly.
- The print media does not meet the usage specification. For example, the print media is textured, damp, or too rough.
- The paper used has been stored in the air for a prolonged time.
- The paper path is dirty.
- Load correct paper. Please refer to [Section 2.4](#) for the way to load paper correctly.
- Please correctly use the medium conforming to the specifications. See [Section 2](#).
- Keep the paper in its original wrapper before use.
- Clean the paper path.

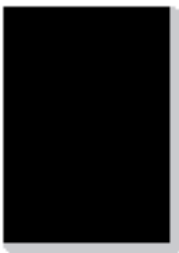

Single color or black images

- Toner cartridge is not installed properly.
- If all-black image appear when copying and scanning, maybe it is scanning exposure, and the cover on the manuscript is not properly closed.
- The scanner is damaged.
- Pull out the toner cartridge tray, remove the toner cartridge, then insert the toner cartridge, and insert the toner cartridge tray.
- Please close the cover on the manuscript, and then carry out copying and scanning.
- Please contact Pantum Customer Service.



Text or image cut off

- The tray fails to load the media properly.
- Toner cartridge is not installed properly.
- There are foreign objects inside the printer.
- Load correct paper. Please refer to [Section 2.4](#) for the way to load paper correctly.
- Pull out the toner cartridge tray, remove the toner cartridge, then insert the toner cartridge, and insert the toner cartridge tray.
- Please contact the customer service center.



Toner comes off easily

- Print media that does not meet the specifications is used. For example, the media weight is not supported by the printer.
- The paper used has been stored in the air for a prolonged time.
- Please correctly use the medium conforming to the specifications. See [Section 2](#).
- Keep the paper in its original wrapper before use.



Uneven print density

- Toner cartridge is not installed properly.
- Pull out the toner cartridge tray, remove the toner cartridge, then insert the toner cartridge, and insert the toner cartridge tray.
- Perform the “Fully Calibrated” setting, please refer to [Section 11.2.2](#) for the setting mode.



Horizontal dark lines

- The paper used has been stored in the air for a prolonged time.
- Toner cartridge is not installed properly.
- Keep the paper in its original wrapper before use.
- Pull out the toner cartridge tray, remove the toner cartridge, then insert the toner cartridge, and insert the toner cartridge tray.



Vertical dark lines

- The paper used has been stored in the air for a prolonged time.
- Toner cartridge is not installed properly.
- The paper path is dirty.
- If black vertical stripes appear when copying or scanning, the scanner or the platen glass may be dirty.
- Scanner Light bulb has smudges.
- The scanner is damaged.
- Keep the paper in its original wrapper before use.
- Pull out the toner cartridge tray, remove the toner cartridge, then insert the toner cartridge, and insert the toner cartridge tray.
- Clean the paper path.
- Clean the scanner or the platen glass.
- Please contact Pantum Customer Service.



Horizontal white lines

- Toner cartridge is not installed properly.
- Pull out the toner cartridge tray, remove the toner cartridge, then insert the toner cartridge, and insert the toner cartridge tray.



Vertical white lines

- The print media does not meet the usage specification. For example, the print media is textured, damp, or too rough.
- Toner cartridge is not installed properly.
- Please correctly use the medium conforming to the specifications. See [Section 2](#).
- Pull out the toner cartridge tray, remove the toner cartridge, then insert the toner cartridge, and insert the toner cartridge tray.



Repetitive defects

- The toner cartridge is damaged. The print quality test page does not meet any of the following measurements:
 - Cartridge:
 - 25.70mm
 - 35.30mm
 - 75.6mm
 - 26.7mm
 - Fuser:
 - 56.5mm
 - Transfer module:
 - 25.10mm
 - 59.70mm
 - 28.30mm
 - 65mm
 - 65mm
- It is recommended to replace with the original toner cartridge.
- Please record the data and contact the customer service center.



Note: • Failures above can be improved by cleaning or replacing toner cartridge. Please contact customer services center if the problem can still not be solved.

14. Product Specifications

 **Note:** • Specification values vary slightly from printers with different models with different functions, and product specifications vary from different countries and regions.

- These values are based on the initial data. For more information about the latest specifications, please visit: www.pantum.com.

14.1. Overview of the Specifications

| | |
|---|---|
| Product Size(W*D*H) | 401mm*411mm*314mm |
| Product weight (including cartridge, excluding the package) | 18.5KG |
| Product weight (including cartridge and package) | 21.2KG |
| Print Environment | Optimal Printing Temp Range: 10-32°C |
| | Print humidity range:20%RH~80%RH |
| Power Voltage | 110V Model: AC110-127V,50Hz/60Hz,7A |
| | 220V Model: AC220-240V,50Hz/60Hz,3.5A |
| Noise (SPL) | Standby: ≤30dB(A) |
| | Print/scan:≤52dB(A) |
| | Copy:≤54dB (A) |
| | Mute mode:≤47dB (A) |
| Enter network standby time | 1 minutes |
| Power Consumption | Shutdown: ≤0.15W |
| | sleep: ≤1W |
| | Standby: ≤10W |
| | Network standby:≤2W |
| | TEC: conforming to requirements of Chinese energy efficiency rating |
| Operating system | Microsoft Windows XP/ Windows 7/ Windows 8/ Windows 8.1/ Windows 10/Windows Server 2012/Windows Server 2016 (32/64 Bit) |
| | macOS 10.9/10.10/10.11/10.12/10.13/10.14/10.15 |
| | Linux(Ubuntu 16.04/ Ubuntu 18.04) |
| | iOS 9.0-14.0 |
| | Android 5.1-10.0 |

| | |
|-------------------------|--|
| Communication interface | USB 2.0 (High Speed) |
| | IEEE802.3 10Base-T/100Base-Tx |
| | IEEE802.11b/g/n (support WPS) |
| | Operation Frequency: 2412Mhz - 2472Mhz |
| | RF output power: ≤ 20 dBm |

14.2. Print Specifications

| | |
|--------------------------|----------------------------|
| Print Speed | 18ppm (A4) /19ppm(Letter) |
| Print Time of First Page | Black & White: ≤ 10 s |
| | Color: ≤ 12 s |
| Print Language | PDL |

14.3. Copy Specifications

| | |
|----------------------|---|
| Copy Speed | Black & White: 18cpm |
| | Color: 18cpm |
| FCOT | FB: ≤ 16 s |
| | ADF: ≤ 18 s |
| Other Copy Functions | ID copy, Receipt copy, N-up copy, Clone copy, Poster Copy |

14.4. Scan Specifications

| | |
|----------------------|----------------------------|
| Scan Type | Flatbed |
| Scanning speed | 18ipm |
| Maximum Scan Size | Flatbed: 216×297mm |
| Scan Mode | Color/Grey/Black & White |
| Scan Output Function | Scan to E-mail, PC and FTP |

PANTUM